



Nectra

- Version BASIC
- Version AUDIT

SERRURE ÉLECTRONIQUE
ELECTRONIC LOCK

Nectra









INDEX

F	FRANÇAIS	<i>page 3</i>
GB	ENGLISH	<i>page 27</i>
E	ESPAÑOL	<i>página 51</i>
D	DEUTSCH	<i>seite 75</i>
I	ITALIANO	<i>pagina 99</i>
P	PORTUGUÊS	<i>pagina 123</i>
NL	NEDERLANDS	<i>pagina 147</i>

SOMMAIRE

1. Introduction	4
1.1 Description du produit	4
1.2 Signalisation	5
1.3 Niveau d'accès utilisateurs.....	5
1.4 Code d'ouverture.....	5
2. Utilisation de la serrure	6
2.1 Alimentation.....	6
2.2 Mise en place de la pile	6
2.3 Ouvrir la porte	7
2.4 Sécuriser la porte.....	8
3. Configuration du système (utilisateur avancé)	9
3.1 Changement d'un code d'ouverture	9
3.2 Activer et désactiver les opérateurs	10
3.3 Réglage des retards	12
3.4 Mode Dual (quatre yeux)	14
3.5 Procédure sous contrainte	16
3.6 Recomposition du code après retard	19
3.7 Signal sonore.....	21
4. Fonction d'audit des serrures	23
5. Diagnostic de pannes	24
6. Garantie	24
7. Réglage usine	25
8. Spécifications techniques	26

Signalétique :

		Eteint
		Allumé
		Clignote
 X2	 X2	Clignote deux fois

1. Introduction

Merci pour votre achat.

Cette serrure permet de contrôler et de protéger l'accès à vos biens.

La serrure offre plusieurs options de configuration.

1.1 Description du produit

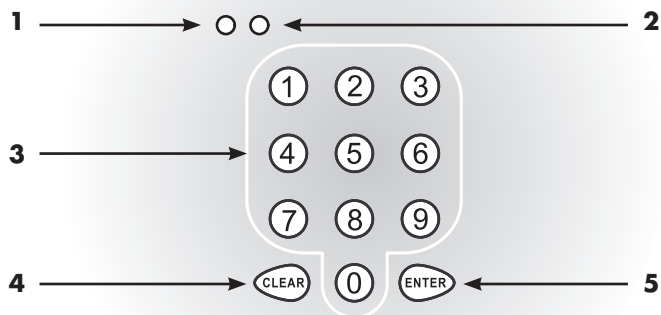

1 - Voyant de signalisation orange.

2 - Voyant de signalisation vert.

3 - Clavier : un appui sur une touche est confirmé par un bip sonore.

4 - Touche "**Clear**" : cette touche permet de verrouiller manuellement la serrure et d'effacer toute saisie de code.

5 - Touche "**Enter**" : cette touche permet de valider la saisie.

1.2 Signalisation

Chaque action correcte est confirmée par un signal sonore composé de 2 bips associés à 2 clignotements du voyant vert.

Chaque action erronée est confirmée par un signal sonore composé de 3 bips associés à trois clignotements du voyant orange.

1.3 Niveau d'accès utilisateurs

Trois niveaux d'accès sont autorisés :

- 1 maître.
- 7 opérateurs.
- 1 C.I.T. (Transfert de fonds).

Seul le code maître peut activer, désactiver ou changer un code.

Le code maître, les codes opérateurs et le code C.I.T. peuvent ouvrir la serrure.

Pour pallier à un oubli de votre code, nous vous conseillons d'avoir au moins deux codes d'ouverture activés.

1.4 Code d'ouverture

Un code d'ouverture peut être composé de 6, 7 ou 8 chiffres.

Les différents codes par défaut sont consultables dans le chapitre 7 : "Réglage usine".



Pour une sécurité optimale, ne pas utiliser de code tel que: 000000....999999, 1234567, 7654321, etc.

2. Utilisation de la serrure

2.1 Alimentation

La serrure peut être alimentée :

- par pile (utilisation autonome).
- par alimentation externe (disponible en option, conseillée pour un usage intensif ou le paramétrage de retards).

2.2 Mise en place de la pile

Lorsque le voyant orange clignote, votre pile est déchargée vous devez alors la remplacer :

- Tournez l'unité de saisie dans le sens antihoraire.
- Retirez le clavier de l'unité de saisie.
- Connectez et mettez en place la pile (utilisez une pile Alcaline 9 volts : type 6LR61).
- Dès que la pile est connectée, la serrure doit confirmer l'opération par 2 bips de validation.
- Fermez l'unité de saisie sans pincer le câblage électrique, verrouillez en tournant dans le sens horaire.
- Un signal sonore de 3 secondes sera émit après chaque réveil de la serrure (le réveil est consécutif à l'appui sur une touche après au moins 10 secondes d'inactivité de la serrure) et ce tant qu'une opération complète d'ouverture n'aura pas été réalisée.

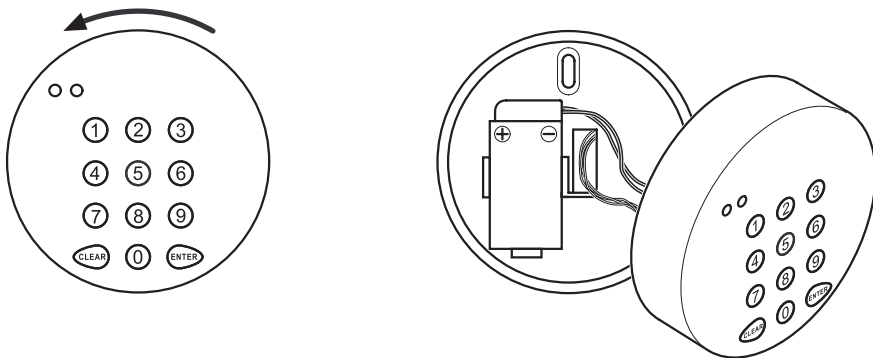

Les codes, les réglages et les blocages sont sauvegardés et protégés contre les coupures de courant.

Ouverture de la porte









F

2.3 Ouvrir la porte

Suivant le paramétrage de la serrure, celle-ci peut s'ouvrir de plusieurs façons :

2.3.1 Ouverture sans retard











	Voyant orange	Voyant vert
 Tapez un code d'ouverture +  et attendez pendant que le voyant vert clignote.		
 Quand le voyant vert est allumé, vous pouvez ouvrir la porte.		

GB

E

D

2.3.2 Ouverture avec retard

	Voyant orange	Voyant vert
 Tapez un code d'ouverture +  et attendez pendant que les voyants orange et vert clignent.		
 Quand la serrure émet des bips, retapez votre code d'ouverture.		
 Quand le voyant vert est allumé, vous pouvez ouvrir la porte.		

I

P

NL

Blocage faux code :



- Si vous tapez trois codes erronés, la serrure sera bloquée 10 minutes.
- Si vous entrez un quatrième code erroné, la serrure sera bloquée 20 minutes.
- Après toute nouvelle tentative, la serrure se bloquera pendant 30 minutes.











- Le code C.I.T. n'est soumis à aucun retard.
- Après la première ouverture, le code d'usine doit être remplacé par un code plus sûr.











Ouverture de la porte







2.3.3 Ouverture en Mode Dual (quatre yeux) sans retard

	Voyant orange	Voyant vert
🔑 Tapez un code d'ouverture + 		
🔑 Quand la serrure émet des bips, tapez un second code d'ouverture + 		
🔑 Quand le voyant vert est allumé, vous pouvez ouvrir la porte.		

2.3.4 Ouverture en Mode Dual (quatre yeux) avec retard

	Voyant orange	Voyant vert
🔑 Tapez un code d'ouverture + 		
🔑 Quand la serrure émet des bips, tapez un second code d'ouverture + 		
🔑 Quand la serrure émet des bips, tapez à nouveau le second code d'ouverture + 		
🔑 Quand le voyant vert est allumé, vous pouvez ouvrir la porte.		

2.4 Sécuriser la porte

	Voyant orange	Voyant vert
🔑 Fermez et verrouillez la porte.		
🔑 La serrure est automatiquement verrouillée.		

Nota : Si la porte n'a pas été ouverte, appuyez sur  pour verrouiller la serrure et sécuriser la porte.

3. Configuration du système (utilisateur avancé)

Nous vous conseillons d'effectuer tout changement de configuration porte ouverte.

3.1 Changement d'un code d'ouverture

	Voyant orange	Voyant vert
👉 Tapez le code maître +		
👉 Quand le voyant vert est allumé, vous pouvez ouvrir la porte.		
*👉 Porte ouverte, retapez le code maître +		
👉 Sélectionnez un utilisateur (9 possibilités) en tapant :		
- "0" + pour le code maître. ou - "1" + pour l'opérateur 1. . ou . - "7" + pour l'opérateur 7. ou - "8" + pour l'opérateur C.I.T.		X2
👉 Tapez le nouveau code +		X2
👉 Retapez le nouveau code +		X2

Si vous souhaitez modifier un autre paramètre, reprenez les opérations au point *



- Un code d'accès peut être composé de 6, 7 ou 8 chiffres.
- Un code peut être modifié même si l'utilisateur n'est pas activé.

Activer et désactiver les opérateurs



3.2 Activer et désactiver les opérateurs

3.2.1 Activer les opérateurs

	Voyant orange	Voyant vert
Tapez le code maître +		
Quand le voyant vert est allumé, vous pouvez ouvrir la porte.		
* Porte ouverte, retapez le code maître +		
Tapez "9" +		X2
Sélectionnez un utilisateur (8 possibilités) en tapant: - "1" + pour l'opérateur 1. ou - "2" + pour l'opérateur 2. . ou . - "7" + pour l'opérateur 7. ou - "8" + pour l'opérateur C.I.T.		X2
Tapez "1" + L'opérateur est activé.		X2

Si vous souhaitez modifier un autre paramètre, reprenez les opérations au point *



Après la première activation d'un opérateur, remplacez le code par défaut par un code plus sûr.

Activer et désactiver les opérateurs



F

3.2.2 Désactiver les opérateurs

	Voyant orange	Voyant vert
☞ Tapez le code maître +		
☞ Quand le voyant vert est allumé, vous pouvez ouvrir la porte.		
* ☞ Porte ouverte, retapez le code maître +		
☞ Tapez "9" +		
☞ Sélectionnez un utilisateur (8 possibilités) en tapant:		
- "1" + pour l'opérateur 1.	}	
ou - "2" + pour l'opérateur 2.		
⋮		
ou - "7" + pour l'opérateur 7.		
ou - "8" + pour l'opérateur C.I.T.		
☞ Tapez "0" +		
L'opérateur est désactivé.		

Si vous souhaitez modifier un autre paramètre, reprenez les opérations au point *



Même si un code désactivé n'autorise pas le déverrouillage, ce code reste en mémoire.

GB

E

D

I

P

NL

Réglage des retards

















3.3 Réglage des retards

La serrure permet la programmation d'un retard à l'ouverture. Ainsi, lorsque vous tapez votre code d'ouverture, une temporisation de la durée du retard programmé s'écoule avant que la serrure ne se déverrouille.

La durée des retards est comprise entre "0" et "99" minutes.

3.3.1 Retard maître

	Voyant orange	Voyant vert
🔑 Tapez le code maître + 		
🔑 Quand le voyant vert est allumé, vous pouvez ouvrir la porte.		
🔑 Porte ouverte, retapez le code maître + 		
🔑 Tapez "13" + 		 X2
🔑 Tapez "le retard en minutes" + 		 X2





















Pour une utilisation intense de la serrure avec retard, nous vous conseillons de relier votre serrure à une alimentation externe 12V (disponible en option).

Réglage des retards

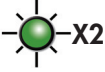

F

3.3.2 Retard opérateurs

	Voyant orange	Voyant vert
 Tapez le code maître + 		
 Quand le voyant vert est allumé, vous pouvez ouvrir la porte.		
 Porte ouverte, retapez le code maître + 		
 Tapez "14" + 		
 Tapez "le retard en minutes" + 		

GB

E

D

I

P

NL



Pour une utilisation intense de la serrure avec retard, nous vous conseillons de relier votre serrure à une alimentation externe 12V (disponible en option).



















Mode Dual (quatre yeux)

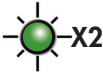

3.4 Mode Dual (quatre yeux)

Dans le Mode Dual, il est nécessaire de composer 2 codes opérateurs afin de pouvoir déverrouiller la serrure.

3.4.1 Activer le Mode Dual (quatre yeux)

	Voyant orange	Voyant vert
 Tapez le code maître + 		
 Quand le voyant vert est allumé, vous pouvez ouvrir la porte.		
 Porte ouverte, retapez le code maître + 		
 Tapez "12" + 		
 Tapez "1" +  La fonction est activée.		



Même en Mode Dual (quatre yeux), le code maître seul ou le code C.I.T. seul autorise le déverrouillage de la porte.















En Mode Dual (quatre yeux), le retard appliqué à l'ouverture est celui du second code composé.

Mode Dual (quatre yeux)

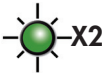

F

3.4.2 Désactiver le Mode Dual (quatre yeux)

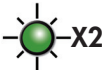
	Voyant orange	Voyant vert
☞ Tapez le code maître + 		
☞ Quand le voyant vert est allumé, vous pouvez ouvrir la porte.		
☞ Porte ouverte, retapez le code maître + 		
☞ Tapez "12" + 		
☞ Tapez "0" +  La fonction est désactivée.		

GB

E

D

I

P

NL

Procédure sous contrainte















3.5 Procédure sous contrainte

Dans le cas où vous seriez menacé lors de la saisie de votre code, la fonction alarme sous contrainte vous permet de commander le déverrouillage de la serrure en appliquant un retard spécifique et /ou en déclenchant une alarme pour prévenir les agents de sécurité.

La procédure sous contrainte s'active en changeant le dernier chiffre du code de +/- 1.

Exemples : 156754 → 156753 ou 156755.
 142789 → 142788 ou 142780.

3.5.1 Activer la procédure sous contrainte

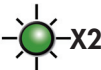
	Voyant orange	Voyant vert
👉 Tapez le code maître + 		
👉 Quand le voyant vert est allumé, vous pouvez ouvrir la porte.		
👉 Porte ouverte, retapez le code maître + 		
👉 Tapez "11" + 		
👉 Tapez "1" +  La fonction est activée.		



Le déclenchement d'une alarme par utilisation de la procédure sous contrainte nécessite le raccordement de votre serrure à une centrale d'alarme reliée à un système de télésurveillance.













Procédure sous contrainte



F

3.5.2 Désactiver la procédure sous contrainte

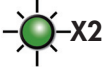
GB

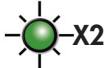
	Voyant orange	Voyant vert
☞ Tapez le code maître + 		
☞ Quand le voyant vert est allumé, vous pouvez ouvrir la porte.		
☞ Porte ouverte, retapez le code maître + 		
☞ Tapez "11" + 		
☞ Tapez "0" +  La fonction est désactivée.		

E

D

I

P















NL

Procédure sous contrainte



3.5.3 Retard procédure sous contrainte

La durée des retards est comprise entre "0" and "99" minutes.

	Voyant orange	Voyant vert
☞ Tapez le code maître + 		
☞ Quand le voyant vert est allumé, vous pouvez ouvrir la porte.		
☞ Porte ouverte, retapez le code maître + 		
☞ Tapez "15" + 		
☞ Tapez "le retard en minutes" + 		



Quand le Mode Dual (quatre yeux) est activé, seul le second utilisateur peut activer ce retard sous contrainte.

















3.6 Recomposition du code après retard

Lorsque vous avez programmé un retard à l'ouverture sur votre serrure, vous pouvez choisir de devoir recomposer, ou non, votre code à l'issue de la temporisation pour obtenir le déverrouillage de la serrure.

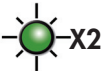
Par défaut, la recomposition du code est activée voir **chapitre 7 : «Réglage usine»**.













3.6.1 Activer la recomposition du code après retard

	Voyant orange	Voyant vert
☞ Tapez le code maître + 		
☞ Quand le voyant vert est allumé, vous pouvez ouvrir la porte.		
☞ Porte ouverte, retapez le code maître + 		
☞ Tapez "17" + 		
☞ Tapez "1" +  La fonction est activée.		

Recomposition du code après retard



3.6.2 Désactiver la recomposition du code après retard

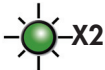

















	Voyant orange	Voyant vert
☞ Tapez le code maître + 		
☞ Quand le voyant vert est allumé, vous pouvez ouvrir la porte.		
☞ Porte ouverte, retapez le code maître + 		
☞ Tapez "17" + 		
☞ Tapez "0" +  La fonction est désactivée.		

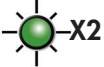

3.7 Signal sonore

Vous pouvez choisir de faire fonctionner votre serrure en mode silencieux (buzzer neutralisé).

3.7.1 Activer le signal sonore

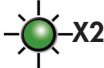
	Voyant orange	Voyant vert
 Tapez le code maître + 		
 Quand le voyant vert est allumé, vous pouvez ouvrir la porte.		
 Porte ouverte, retapez le code maître + 		
 Tapez "10" + 		
 Tapez "1" +  La fonction est activée.		





















Attention, nous attirons votre attention sur le fait que l'utilisation de la serrure en mode silencieux est moins intuitive, cette fonction est donc à réserver aux utilisateurs ayant une bonne maîtrise de la serrure.

Signal sonore



3.7.2 Désactiver le signal sonore

	Voyant orange	Voyant vert
 Tapez le code maître + 		
 Quand le voyant vert est allumé, vous pouvez ouvrir la porte.		
 Porte ouverte, retapez le code maître + 		
 Tapez "10" + 		
 Tapez "0" +  La fonction est désactivée.		



Seules les alarmes restent audibles lorsque le signal sonore est désactivé (voir Diagnostic de pannes).



4. Fonction d'audit des serrures

Si vous avez fait l'acquisition d'une serrure incluant la fonction Audit, cette serrure conserve en mémoire (et de façon permanente) jusqu'à 500 événements.

Pour pouvoir lire les événements contenus dans la serrure, il est nécessaire de disposer du boîtier de récupération BTXN, du câble de liaison avec un PC et du logiciel XN_Tool permettant l'exploitation des données.

Le boîtier BTXN permet de gérer la récupération d'événements sur 16 serrures.

Tous ces éléments sont disponibles en option (contacter votre revendeur).



5. Diagnostic de pannes

- **Le voyant orange clignote une dizaine de fois lentement.**

⇒ La pile de votre serrure est déchargée : il faut la remplacer.

- **Le voyant orange clignote trois fois après un appui sur une touche.**

⇒ La serrure est en blocage par code erroné (saisie d'au moins 3 codes erronés successifs) : attendre la fin de la temporisation de blocage avant de procéder à un nouvel essai (se reporter au Chapitre 2.3).

- **Le voyant orange clignote avec un signal sonore deux tons.**

⇒ Le mécanisme d'ouverture est entravé : contacter votre revendeur.

- **La serrure émet un long signal sonore après un appui sur une touche.**

⇒ L'unité de saisie a été ouverte : ce signal disparaîtra lors de la prochaine ouverture.

- **Les voyants vert et orange clignotent simultanément et la serrure émet un signal sonore composé de deux bips.**

⇒ La communication entre unité de saisie et unité de sécurité (à l'intérieur du coffre) ne s'est pas correctement établie : contacter votre revendeur.

6. Garantie

En cas de besoin, le vendeur de votre coffre est le premier habilité à intervenir.

A défaut (déménagement de votre part, fermeture du magasin où vous l'avez acheté...), veuillez consulter le Service Après-Vente qui vous communiquera l'adresse d'un professionnel qualifié dépositaire de la marque proche de chez vous.

En cas d'intervention sur votre appareil, exigez du Service Après-Vente les pièces de rechange certifiées constructeur.

En appelant le Service Après-Vente, indiquez-lui le modèle et le numéro de matricule de votre coffre.



Nous ne pouvons être tenus responsable en cas de problème apparaissant sur une serrure modifiée ou pour laquelle les pièces d'origine n'ont pas été utilisées.



7. Réglage usine

Réglage par défaut en usine

		Code d'ouverture par défaut	
Configuration du code	Maître	000000	Activé
	Opérateur 1	111111	Désactivé
	Opérateur 2	222222	Désactivé
	Opérateur 3	333333	Désactivé
	Opérateur 4	444444	Désactivé
	Opérateur 5	555555	Désactivé
	Opérateur 6	666666	Désactivé
	Opérateur 7	777777	Désactivé
	C.I.T.	888888	Désactivé

Retard	Retard code maître	0 min
	Retard code opérateur	0 min
	Retard procédure sous contrainte	0 min

Réglage	Signal sonore	Activé
	Mode quatre yeux	Désactivé
	Câble relais	Désactivé
	Procédure sous contrainte	Désactivé
	Recomposition du code après retard	Activé



8. Spécifications techniques

Les caractéristiques électriques de la Combinaison **Nectra** sont les suivantes :

Alimentation :

Une pile alcaline 9 volts /
550 mAh type 6LR61
Une alimentation extérieure

Tension d'alimentation :

8 volts à 18 volts

Consommation :

18 μ A en veille
4,5 mA au réveil
300 mA quand le moteur tourne

Force que peut exercer le composant de verrouillage

10N avec alimentation à 9VDC.

Matériaux de l'unité de stockage sur lesquels la serrure peut être fixée

Matériaux métalliques ou composites résistant au vissage et serrage.

Dimensions des trous des serrures, tiges ou passages de câbles

Trou de passage du câble reliant l'unité de sécurité au terminal : Trou rond de diamètre 5 mm à 13 mm.

Dimensions mécaniques :

Terminal :

D = 90 mm
H = 35 mm

Unité de sécurité :

L = 87 mm
H = 61 mm
P = 36 mm

Environnement :

Température de fonctionnement :

-10 à +55°C

Humidité relative :

20 à 80 %

Recommandations relatives à la protection des serrures contre les attaques destructives

Le trou de passage du câble reliant l'unité de sécurité au terminal doit être déporté par rapport à la position de l'unité de sécurité.

Installation des contacts pènes







Les contacts pènes sont des microswitchs idéalement situés directement sur les pièces de serrurerie ou sinon sur la partie mobile de la tringlerie.

Le contact du microswitch doit être appuyé lorsque le coffre est fermé.

CONTENTS

1. Introduction	28
1.1 Product Description	28
1.2 Warning indicators	29
1.3 User access levels	29
1.4 Opening code	29
2. Using the lock	30
2.1 Power supply.....	30
2.2 Installing batteries	30
2.3 Opening the door	31
2.4 Securing the door	32
3. Configuration of the system (advanced user)	33
3.1 Changing an opening code	33
3.2 Activating and deactivating operators	34
3.3 Setting time delays	36
3.4 Dual access opening mode (4 eyes mode)	38
3.5 Duress alarm procedure.....	40
3.6 Reconfirming the code after time delay has elapsed	43
3.7 Buzzer.....	45
4. Audit trail function	47
5. Troubleshooting	48
6. Warranty	48
7. Factory settings	49
8. Technical specifications	50

Signalling :

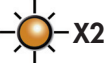
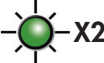
		Switched off
		Switched on
		Flashing
		Flashing twice



1. Introduction

Thank you for choosing the NECTRA lock.

This lock will protect and allow restrictive access to your safe / cabinet.

Several configuration options are available.

1.1 Product Description

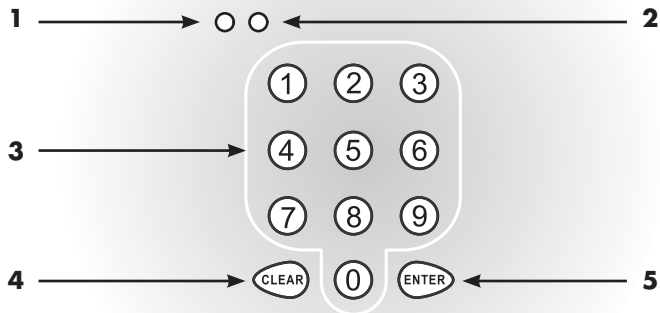

1 - Orange light.

2 - Green light.

3 - Keypad : a sound (beep) is emitted when a key is pressed.

4 - "**Clear**" key : manually relocks the lock and erases any input.

5 - "**Enter**" key : validates input.



1.2 Warning indicators

Each correct action is confirmed by a 2-beep sound with a 2 green light flashes.

A wrong action will be sanctioned by a 3-beep sound with 3 orange light flashes.

1.3 User access level

Three access levels are possible :

- 1 Master Code.
- 7 Operators.
- 1 C.I.T. (Cash In Transit).

The master code is the only one allowing the user to activate, inactivate or change a code. The master, operators and C.I.T. codes can open the lock.

To avoid any opening problem (lost code), we advise you to activate at least 2 operator codes.

1.4 Opening code

The opening code may be made up of 6,7 or 8 digits.

For default codes, please refer to chapter 7 : "Factory Settings".



For maximal security, avoid using codes such as : 000000....999999, 1234567, 7654321, etc.

2. Using the lock

2.1 Power supply

The lock can be powered by :

- Batteries.
- External power supply (available as an option, for frequent use and time delay, please contact your retailer).

2.2 Installing batteries

When the orange light flashes, batteries are flat and need to be replaced:

- ☞ Turn the keypad anticlockwise.
- ☞ Separate the keypad housing from the keypad.
- ☞ Insert and connect battery (use a 9 volts alkaline battery : 6LR61 type).
- ☞ The lock will beep twice to confirm the connection.
- ☞ Clip on the keypad housing carefully not to trap the electric cable, then turn the keypad clockwise to close it.
- ☞ An alarm sound is emitted each time the lock is woken up (the lock wakes up by pressing a key after at least 10 seconds of inactivity) until a complete opening session has been carried out.

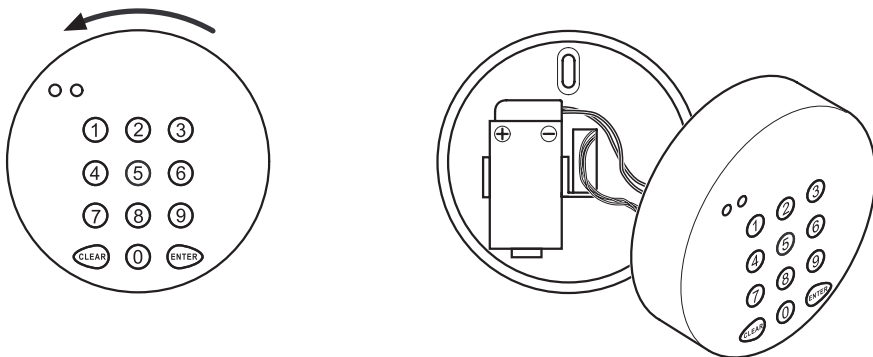

Codes, settings and blockings are stored and protected during power cuts.

Opening the door









F

GB

2.3 Opening the door

Depending on the settings, the lock can be opened in different ways :











2.3.1 Opening without delay

	Orange light	Green light
 Type in an opening code +  and wait as long as the green light flashes.		
 Open the door when the green light is displayed.		

E

D

2.3.2 Opening with delay

	Orange light	Green light
 Type in an opening code +  and wait as long as both the green and the orange lights are flashing.		
 When the lock emits a beep every second, type in the opening code again.		
 Open the door when the green light is displayed.		

I

P

NL

Wrong code blocking :



- If you type in 3 wrong codes successively, the lock will be blocked for 10 minutes (no input possible).
- This blocking will last 20 minutes after entering a fourth wrong code.
- Any other entering of a wrong code will lead to a 30 minutes blocking.











- The C.I.T. operators always have immediate access (no time delay).
- After the first opening, the factory code must be replaced by a safer one (your personal secret code).











Opening the door



2.3.3 Dual access opening without delay (Four eyes mode)

	Orange light	Green light
☞ Type in an opening code + 		
☞ When the lock beeps every second, type in a second opening code + 		
☞ Open the door when the green light is displayed.		

2.3.4 Dual access opening with delay (Four eyes mode)

	Orange light	Green light
☞ Type in an opening code + 		
☞ When the lock beeps every second, type in a second opening code + 		
☞ When the lock beeps every second, type in again the second opening code + 		
☞ Open the door when the green light is displayed.		

2.4 Securing the door

	Orange light	Green light
☞ Close and bolt the door.		
☞ The door is automatically secured.		

NB : If the door has not been unbolted, press  to secure it.

Changing an opening code



F

GB

E

D

I

P

NL

3. Configuration of the system (advanced user)

Keep the door opened while changing the configuration.

3.1 Changing an opening code

	Orange light	Green light
☞ Type in the master code +		
☞ When the green light is displayed, open the door.		
* ☞ Door opened, type in master code again +		
☞ Select one operator (9 possibilities) by typing :		
- "0" + for master code.	}	
or		
- "1" + for operator 1.		
⋮		
or		
- "7" + for operator 7.		
or		
- "8" + for C.I.T. operator.		
☞ Type in the new code +		
☞ Type in the new code again +		

If you wish to modify another setting, go back to point * and repeat the operations.



- An opening code may be made up of 6, 7 or 8 digits.
- You can modify the code even if the operator is not activated.

Activating / deactivating operators



3.2 Activating and deactivating operators

3.2.1 Activating operators

	Orange light	Green light
☞ Type in the master code +		
☞ When the green light is displayed, open the door.		
* ☞ Door opened, type in master code again +		
☞ Type "9" +		
☞ Select an operator (8 possibilities) by typing :		
- "1" + for operator 1. or - "2" + for operator 2. . or . - "7" + for operator 7. or - "8" + for C.I.T. operator.		
☞ Type "1" + The operator's code is activated.		

If you wish to modify another setting, go back to point * and repeat the operations.



Once an operator's code has been activated for the first time, change the factory (or default) code for a safer one.

Activating / deactivating operators



F

GB

E



















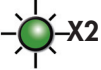

D

I

P

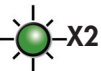
NL

3.2.2 deactivating operators

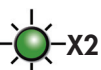
	Orange light	Green light
☞ Type in the master code + 		
☞ When the green light is displayed, open the door.		
* ☞ Door opened, type in master code again + 		
☞ Type "9" + 		
☞ Select an operator (8 possibilities) by typing :		
- "1" +  for operator 1.		
or		
- "2" +  for operator 2.		
or		
- "7" +  for operator 7.		
or		
- "8" +  for C.I.T. operator		
☞ Type "0" +  The operator's code is deactivated.		

If you wish to modify another setting, go back to point * and repeat the operations.



Even if an deactivated code does not allow the opening, it is kept in memory.

Setting delays

















3.3 Setting time delays

The lock allows the user to set a delay before opening: when a code is entered, a delay timer is counted down before the bolt releases.

The delay timer can be set from "0" to "99" minutes.

3.3.1 Master code delay

	Orange light	Green light
☞ Type in the master code + 		
☞ When the green light is displayed, open the door.		
☞ Door opened, type in master code again + 		
☞ Type "13" + 		
☞ Type "delay duration in minutes" + 		





















For a frequent use of the lock with a delay, we strongly recommend that you power your lock with an external 12V DC power supply (available as an option, please contact your retailer).

Setting delays



3.3.2 Operator delay

	Orange light	Green light
 Type in the master code + 		
 When the green light is displayed, open the door.		
 Door opened, type in master code again + 		
 Type "14" + 		
 Type "delay duration in minutes" + 		



For a frequent use of the lock with a delay, we strongly recommend that you power your lock with an external 12V DC power supply (available as an option, please contact your retailer).

Dual access opening (4 eyes mode)



3.4 Dual access opening mode (4 eyes mode)

In this mode, two different codes have to be dialled to release the opening of the lock.

3.4.1 Activating the dual access opening mode (4 eyes mode)

	Orange light	Green light
Type in the master code +		
When the green light is displayed, open the door.		
Door opened, type in master code again +		
Type "12" +		X2
Type "1" + The function is activated.		X2



Even if the dual access mode is activated, the master code or the C.I.T code alone allows the unlocking of the door.

















When in dual access mode, the delay applied before opening is the one of the second code dialled.

Dual access opening (4 eyes mode)



3.4.2 Deactivating the dual access opening mode (4 eyes mode)

	Orange light	Green light
☞ Type in the master code + 		
☞ When the green light is displayed, open the door.		
☞ Door opened, type in master code again + 		
☞ Type "12" + 		
☞ Type "0" +  The function is deactivated.		

F

GB

E

D

I

P

NL

Duress alarm















3.5 Duress alarm procedure

In case of a threat during code input, the duress alarm procedure allows the user to open the lock with a specific delay and/or can activate a silent alarm to warn the security staff.

The duress alarm procedure is activated by changing the last digit of the code by +/- 1.

Example : 156754 → 156753 or 156755.
 142789 → 142788 or 142780.

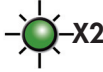
3.5.1 Activating the duress alarm

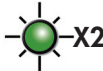
	Orange light	Green light
☞ Type in the master code + 		
☞ When the green light is displayed, open the door.		
☞ Door opened, type in master code again + 		
☞ Type "11" + 		
☞ Type "1" +  The function is activated.		















To be able to raise a silent alarm, your lock needs to be connected to an alarm system which has to be linked to a central monitoring station.

Duress alarm

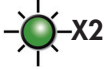

3.5.2 Deactivating the duress alarm

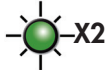
	Orange light	Green light
☞ Type in the master code + 		
☞ When the green light is displayed, open the door.		
☞ Door opened, type in master code again + 		
☞ Type "11" + 		
☞ Type "0" +  The function is deactivated.		

F

GB

E

D

I

P















NL

Duress alarm



3.5.3 Setting the duress alarm procedure delay

The delay timer can be set from "0" to "99" minutes.

	Orange light	Green light
☞ Type in the master code + 		
☞ When the green light is displayed, open the door.		
☞ Door opened, type in master code again + 		
☞ Type "15" + 		 X2
☞ Type "delay duration in minutes" + 		 X2



If the 2 codes release mode (4 eyes mode) is activated, the duress delay can only be activated by the second operator (second code dialled).

Reconfirming the code

















3.6 Reconfirming the code after time delay has elapsed

When a delay before opening is set on the lock, you can choose to re-dial, or not, the code when the delay has elapsed.

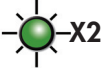
The default setting of the lock is : code reconfirmation activated, refer to **chapter 7 : «Factory settings»**.

3.6.1 Activating the code reconfirmation after delay

	Orange light	Green light
☞ Type in the master code + 		
☞ When the green light is displayed, open the door.		
☞ Door opened, Type in master code again + 		
☞ Type "17" + 		 -X2
☞ Type "1" +  The function is inactivated.		 -X2

F

GB

E

D

I













P

NL

Reconfirming the code

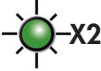

3.6.2 Deactivating the code reconfirmation after delay

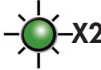
	Orange light	Green light
☞ Type in the master code + 		
☞ When the green light is displayed, open the door.		
☞ Door opened, type in master code again + 		
☞ Type "17" + 		
☞ Type "0" +  The function is activated.		















Buzzer

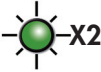

3.7 Buzzer

The lock can be set to silent mode (buzzer off).

3.7.1 Activating the buzzer

	Orange light	Green light
☞ Type in the master code + 		
☞ When the green light is displayed, open the door.		
☞ Door opened, type in master code again + 		
☞ Type "10" + 		
☞ Type "1" +  The function is activated.		





















Warning : the silent mode being far less user friendly, we recommend using this function only when strictly required and only for well trained advanced users.

Buzzer

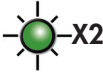

3.7.2 Deactivating the buzzer

	Orange light	Green light
 Type in the master code + 		
 When the green light is displayed, open the door.		
 Door opened, type in master code again + 		
 Type "10" + 		
 Type "0" +  The function is deactivated.		



The alarms and warning signals sounds remain active even when the buzzer is off (please refer to the troubleshooting section).



4. Audit trail function

If you own an audit version, the lock will store all the events happening when using it. It can keep permanently up to 500 time-stamped events.

To be able to read out the events from the lock, you need to purchase an event retrieving unit called BTXN. A specific cable and a software are supplied with the BTXN to use and analyse the data collected on a PC.

A BTXN unit is able to manage up to 16 locks.

This set of components (BTXN + Software + Cable) is available as an option (please contact your retailer).



5. Troubleshooting

- The orange light blinks slowly about 10 times.

⇒ The batteries are low and need to be replaced.

- The orange light blinks three times when pressing a key.

⇒ The lock is in a wrong code blocking situation (at least 3 wrong codes were dialled successively) : wait until the end of the blocking timing and try again (please refer to chapter 2.3).

- The orange light flashes with a dual tone sound.

⇒ The opening mechanism is jammed : please contact your retailer.

- The lock emits a long beep when a key is pressed.

⇒ The keypad has been opened : this signal will disappear at the next opening.

- Green and orange lights both flash simultaneously and the lock beeps twice on every flash.

⇒ The communication between the keypad and the security unit (inside the safe) is not established : please contact your retailer.

6. Warrantry

If needed, your installer / reseller is the first person able to assist.

If he cannot be contacted (if you have moved, or the store you bought the equipment from has closed...) please contact the After-Sales Service who will indicate the nearest address of a qualified service engineer.

If your equipment requires servicing, always request Manufacturer Certified spare parts.

Before calling the After-Sales Service, please check the type and serial number of the safe.



We are not responsible for any problem happening on a modified lock or on a lock on which original manufactured parts were not used.

Factory settings



F

GB

E

D

I

P

NL

7. Factory settings

Default factory settings

		Default opening code	
Code configuration	Master	000000	Active
	Operator 1	111111	Inactive
	Operator 2	222222	Inactive
	Operator 3	333333	Inactive
	Operator 4	444444	Inactive
	Operator 5	555555	Inactive
	Operator 6	666666	Inactive
	Operator 7	777777	Inactive
	C.I.T. operator	888888	Inactive

Delay	Master code delay	0 min
	operator delay	0 min
	Duress alarm procedure delay	0 min

General settings	Buzzer	Active
	Dual access (4 eyes mode)	Inactive
	Relayed output cable	Inactive
	Relayed output set to duress alarm	Inactive
	Code Reconfirming	Active



8. Technical specifications

The electrical characteristics of the **Nectra** combination lock are as follows:

Power supply:

- One 9 Volt/550 mAh alkaline battery (type 6LR61)
- One external power supply

Supply voltage:

8 volts to 18 volts

Consumption:

- 18 μ A on standby
- 4.5 mA on wakeup
- 300 mA with the motor running

Force which can be exerted by the blocking component

10N with a 9VDC power supply.

Materials of secure storage unit to which the lock can be fitted

Metal or composite materials that are able to withstand screwing or tightening.

Dimensions of the lock, boltwork or cable way holes

Cable way hole connecting the secure unit to the terminal: Round hole 5 to 13 mm in diameter.

Mechanical dimensions:

Terminal:

D = 90 mm
H = 35 mm

Security unit:

L = 87 mm
H = 61 mm
P = 36 mm

Environment:

Operating temperature:

-10 to +55°C

Humidity:

20 to 80 %

Recommendations for protecting the lock against destructive attacks

The cable way hole connecting the secure unit to the terminal must be some distance away from the secure unit's position.

Installation of bolt switches







The bolt switches are micro-switches which should ideally be located directly on the lock components, otherwise on the mobile section of the boltwork.

The micro-switch's contact should be pushed when the safe is closed.

SUMARIO

1. Introducción	52
1.1 Descripción del producto	52
1.2 Señalización	53
1.3 Nivel de acceso de los usuarios.....	53
1.4 Códigos de apertura	53
2. Utilización de la cerradura	54
2.1 Alimentación	54
2.2 Instalación de la pila	54
2.3 Apertura de la puerta.....	55
2.4 Protección de la puerta.....	56
3. Configuración del sistema (usuario avanzado)	57
3.1 Cambio de un código de apertura.....	57
3.2 Activación y desactivación de los operadores	58
3.3 Ajuste de los retardos.....	60
3.4 Modo Dual (cuatro ojos)	62
3.5 Procedimiento bajo coacción	64
3.6 Repetición del código después del retardo.....	67
3.7 Señal sonora.....	69
4. Función de auditoría de las cerraduras	71
5. Diagnóstico de averías	72
6. Garantía	72
7. Ajustes de fábrica	73
8. Especificaciones técnicas	74

Señalización:

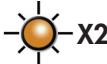
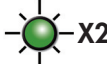
		Apagado
		Encendido
		Intermitente
		Intermitente dos veces

1. Introducción

Le damos las gracias por la compra realizada.

Esta cerradura permite controlar y proteger el acceso a sus bienes.

La cerradura ofrece varias opciones de configuración.

1.1 Descripción del producto

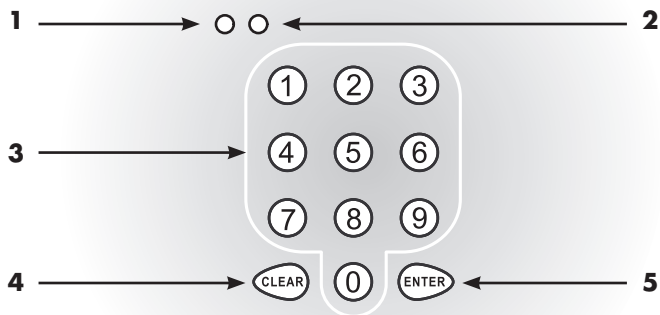

1 - Indicador luminoso de señalización, naranja.

2 - Indicador luminoso de señalización, verde.

3 - Teclado: una señal sonora ("bip") confirma la pulsación de esta tecla.

4 - Tecla "**Clear**": esta tecla permite cerrar manualmente la cerradura y abortar toda introducción de código.

5 - Tecla "**Enter**": esta tecla permite validar el valor introducido.



1.2 Señalización

Cada acción correcta está confirmada por una señal sonora de 2 “bips” asociados a 2 intermitencias del indicador luminoso verde.

Cada acción errónea está confirmada por una señal sonora de 3 “bips” asociados a 3 intermitencias del indicador luminoso naranja.

1.3 Nivel de acceso de los usuarios

Tres niveles de acceso están autorizados:

- 1 maestro.
- 7 operadores.
- 1 C.I.T. (transporte de fondos).

Sólo el código maestro puede activar, desactivar ó cambiar un código.
El código maestro, los códigos de operador y el código C.I.T. pueden abrir la cerradura.

Para paliar el olvido de un código, le recomendamos tener al menos dos códigos de apertura activados.

1.4 Códigos de apertura

Un código de apertura puede tener 6, 7 ó 8 cifras.

Se pueden consultar los diferentes códigos por defecto en el capítulo 7: “Ajustes de fábrica”.



Para una seguridad óptima, se aconseja no utilizar códigos tales como: 000000....999999, 1234567, 7654321, etc.

2. Utilización de la cerradura

2.1 Alimentación

Se puede alimentar la cerradura mediante:

- pila (utilización autónoma).
- un sistema de alimentación externa (disponible como opción, recomendado para un uso intensivo de aperturas ó con largos tiempos de retardo).

2.2 Instalación de la pila

Cuando el indicador luminoso naranja parpadea 10 veces, su pila está descargada y debe cambiarla:

- ☞ Gire el conjunto teclado en sentido antihorario.
- ☞ Retire el teclado del soporte fijado a la Caja.
- ☞ Conecte e instale la pila (utilice una pila alcalina de 9 V: tipo 6LR61).
- ☞ Una vez que la pila esté conectada, la cerradura debe confirmar la operación con 2 “bips” de validación.
- ☞ Situe el Teclado nuevamente delante del soporte base, cuidando no apretar los cables. Bloquee girando en sentido horario.
- ☞ Se oirá una señal sonora de 3 segundos después de cada activación de la cerradura (la activación es consecutiva a la pulsación de una tecla después de al menos 10 segundos de inactividad de la cerradura), hasta que no se realice un ciclo de apertura.

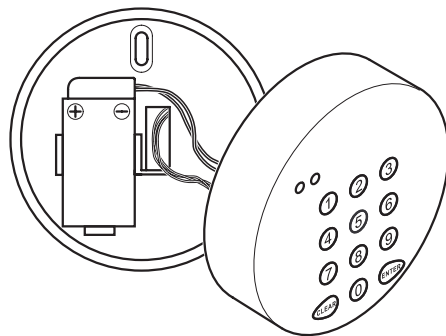
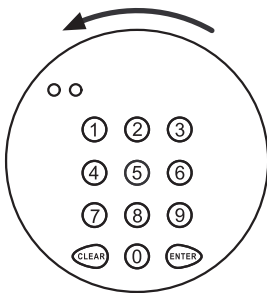







Los códigos, ajustes y bloqueos están salvaguardados y protegidos contra los cortes de corriente.













2.3 Apertura de la puerta

Según la configuración de la cerradura, ésta se puede abrir de varias maneras:

2.3.1 Apertura sin retardo

	Luz naranja	Luz verde
 Introduzca un código de apertura +  y espere mientras que el indicador luminoso verde esté intermitente.		
 Cuando el indicador luminoso verde está encendido, se puede abrir la puerta.		

2.3.2 Apertura sin retardo

	Luz naranja	Luz verde
 Introduzca un código de apertura +  y espere mientras que los indicadores luminosos naranja y verde estén intermitentes.		
 Cuando la cerradura emita «bips», vuelva a introducir su código de apertura.		
 Cuando el indicador luminoso verde está encendido, se puede abrir la puerta.		

Bloqueo por código falso:



- Si introduce tres códigos erróneos sucesivos, la cerradura quedará bloqueada 10 minutos.
- Si introduce un cuarto código erróneo, la cerradura quedará bloqueada 20 minutos.
- Después, con todo nuevo intento, la cerradura quedará bloqueada durante 30 minutos.











- El código C.I.T. no está sometido a ningún retardo.
- Después de la primera apertura, le aconsejamos cambiar el código de fábrica por otro más seguro.











Apertura de la puerta

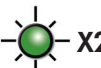





2.3.3 Apertura en Modo Dual (cuatro ojos) sin retardo Los 2 códigos deben ser de operador

	Luz naranja	Luz verde
☞ Introduzca un código de apertura + 		
☞ Cuando la cerradura emita "bips", introduzca un segundo código de apertura + 		
☞ Cuando el indicador luminoso verde está encendido, se puede abrir la puerta.		

2.3.4 Apertura en Modo Dual (cuatro ojos) con retardo

	Luz naranja	Luz verde
☞ Introduzca un código de apertura + 		
☞ Cuando la cerradura emita "bips", introduzca un segundo código de apertura + 		
☞ Cuando la cerradura emita "bips", introduzca nuevamente el segundo código de apertura + 		
☞ Cuando el indicador luminoso verde está encendido, se puede abrir la puerta.		

2.4 Protección de la puerta

	Luz naranja	Luz verde
☞ Cierre y bloquee la puerta.		
☞ La cerradura se bloquea automáticamente.		

Nota: Si no se ha abierto la puerta,
pulse  para bloquear manualmente la cerradura y proteger la puerta.



3. Configuración del sistema (usuario avanzado)

Recomendamos efectuar todo cambio de configuración con la puerta abierta. Verifique el buen funcionamiento del nuevo código varias veces antes de cerrar la puerta.

3.1 Cambio de un código de apertura

	Luz naranja	Luz verde
☞ Introduzca el código maestro +		
☞ Cuando el indicador luminoso verde está encendido, se puede abrir la puerta.		
* ☞ Con la puerta abierta, vuelva a introducir el código maestro +		
☞ Seleccione un usuario (9 posibilidades) introduciendo:		
- "0" + para el código maestro.	}	}
ó		
- "1" + para el operador 1.		
ó		
- "7" + para el operador 7.		
ó		
- "8" + para el operador C.I.T.		
☞ Introduzca el nuevo código +		-X2
☞ Vuelva a introducir el nuevo código +		-X2

Si desea modificar otro parámetro, reanude las operaciones en el punto *



- Un código de acceso puede tener 6, 7 ó 8 cifras.
- Se puede modificar un código incluso si el usuario no está activado.

Activación y desactivación de los operadores



3.2 Activación y desactivación de los operadores

3.2.1 Activación de los operadores

	Luz naranja	Luz verde
Introduzca el código maestro +		
Cuando el indicador luminoso verde está encendido, se puede abrir la puerta.		
* Con la puerta abierta, vuelva a introducir el código maestro +		
Introduzca "9" +		
Seleccione un usuario (8 posibilidades) introduciendo: - "1" + para el operador 1. ó - "2" + para el operador 2. ó - "7" + para el operador 7. ó - "8" + para el operador C.I.T.		
Introduzca "1" + El operador está activado.		

Si desea modificar otro parámetro, reanude las operaciones en el punto *



















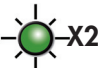

Después de la primera apertura, le aconsejamos cambiar el código por defecto por otro más seguro.

Activación y desactivación de los operadores

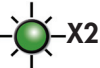

3.2.2 Desactivación de los operadores

	Luz naranja	Luz verde
☞ Introduzca el código maestro + 		
☞ Cuando el indicador luminoso verde está encendido, se puede abrir la puerta.		
* ☞ Con la puerta abierta, vuelva a introducir el código maestro + 		
☞ Introduzca "9" + 		
☞ Seleccione un usuario (8 posibilidades) introduciendo:		
- "1" +  para el operador 1.		
ó - "2" +  para el operador 2.		
ó · · ·		
ó - "7" +  para el operador 7.		
ó - "8" +  para el operador C.I.T.		
☞ Introduzca "0" + 		
El operador está desactivado.		

Si desea modificar otro parámetro, reanude las operaciones en el punto *



Un código desactivado no permite la apertura de la cerradura, pero queda guardado en la memoria.













Ajuste de los retardos



3.3 Ajuste de los retardos

La cerradura permite programar un retardo a la apertura. Así, cuando introduce su código de apertura, transcurre un lapso de tiempo programado antes de que se desbloquee la cerradura. La duración de los retardos está comprendida entre "0" y "99" minutos.

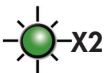
3.3.1 Retardo maestro

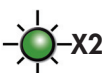
	Luz naranja	Luz verde
👉 Introduzca el código maestro + 		
👉 Cuando el indicador luminoso verde está encendido, se puede abrir la puerta.		
👉 Con la puerta abierta, vuelva a introducir el código maestro + 		
👉 Introduzca "13" + 		
👉 Introduzca "el retardo en minutos" + 		





















Para un uso intenso de la cerradura con largos tiempos de retardo, recomendamos conectar su cerradura a una alimentación externa de 12 V (disponible como opción).

Ajuste de los retardos

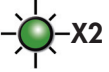

3.3.2 Retardo de operadores

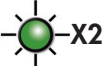
	Luz naranja	Luz verde
 Introduzca el código maestro + 		
 Cuando el indicador luminoso verde está encendido, se puede abrir la puerta.		
 Con la puerta abierta, vuelva a introducir el código maestro + 		
 Introduzca "14" + 		
 Introduzca "el retardo en minutos" + 		



Para un uso intenso de la cerradura con largos tiempos de retardo, recomendamos conectar su cerradura a una alimentación externa de 12 V (disponible como opción).

Modo Dual (cuatro ojos)



3.4 Modo Dual (cuatro ojos)

En Modo Dual, es necesario introducir 2 códigos de operador para poder desbloquear la cerradura.

3.4.1 Activación del Modo Dual (cuatro ojos)

	Luz naranja	Luz verde
Introduzca el código maestro +		
Cuando el indicador luminoso verde está encendido, se puede abrir la puerta.		
Con la puerta abierta, vuelva a introducir el código maestro +		
Introduzca "12" +		-X2
Introduzca "1" + La función está activada.		-X2



Incluso en Modo Dual (cuatro ojos), el código maestro solo ó el código C.I.T. solo, permiten desbloquear la cerradura.



En Modo Dual (cuatro ojos), el retardo aplicado a la apertura es aquel del segundo código introducido.

Modo Dual (cuatro ojos)



3.4.2 Desactivación del Modo Dual (cuatro ojos)

	Luz naranja	Luz verde
Introduzca el código maestro +		
Cuando el indicador luminoso verde está encendido, se puede abrir la puerta.		
Con la puerta abierta, vuelva a introducir el código maestro +		
Introduzca "12" +		-X2
Introduzca "0" + La función está desactivada.		-X2

F

GB

E

D

I

P

NL

Procedimiento bajo coacción

















3.5 Procedimiento bajo coacción

En caso de que estuviere amenazado cuando introduce su código, la función de alarma bajo coacción permite accionar el desbloqueo de la cerradura aplicando un retardo específico y activando una salida de alarma.

El procedimiento bajo coacción se activa cambiando la última cifra del código +/- 1.

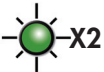
Ejemplos: 156754 → 156753 ó 156755.
142789 → 142788 ó 142780.

3.5.1 Activar el procedimiento bajo coacción

	Luz naranja	Luz verde
☞ Introduzca el código maestro + 		
☞ Cuando el indicador luminoso verde está encendido, se puede abrir la puerta.		
☞ Con la puerta abierta, vuelva a introducir el código maestro + 		
☞ Introduzca "11" + 		
☞ Introduzca "1" +  La función está activada.		

La activación de una alarma por uso del procedimiento bajo coacción necesita que se conecte la cerradura a una central de alarma que esté, a su vez, conectada a un sistema de televigilancia (disponible como opción).

















Cuando el Modo Dual (cuatro ojos) está activado, tanto el primero como el segundo código pueden activar la salida de alarma.

Procedimiento bajo coacción



3.5.2 Desactivar el procedimiento bajo coacción

	Luz naranja	Luz verde
☞ Introduzca el código maestro + 		
☞ Cuando el indicador luminoso verde está encendido, se puede abrir la puerta.		
☞ Con la puerta abierta, vuelva a introducir el código maestro + 		
☞ Introduzca "11" + 		 -X2
☞ Introduzca "0" +  La función está desactivada.		 -X2

F

GB

E

D

I

P

NL

Procedimiento bajo coacción



3.5.3 Retardo en el procedimiento bajo coacción

La duración de los retardos está comprendida entre "0" y "99" minutos.

	Luz naranja	Luz verde
Introduzca el código maestro +		
Cuando el indicador luminoso verde está encendido, se puede abrir la puerta.		
Con la puerta abierta, vuelva a introducir el código maestro +		
Introduzca "15" +		X2
Introduzca "el retardo en minutos" +		X2



Cuando el Modo Dual (cuatro ojos) está activado, sólo el segundo usuario puede activar este retardo bajo coacción.

















3.6 Repetición del código después del retardo

Cuando ha programado un retardo a la apertura de su cerradura, es posible elegir el volver a repetir, o no, su código al finalizar la temporización, para desbloquear la cerradura.

Por defecto, la repetición del código está activada, véase el capítulo 7: "Ajustes de fábrica".















3.6.1 Activación de la repetición del código después del retardo

	Luz naranja	Luz verde
☞ Introduzca el código maestro + 		
☞ Cuando el indicador luminoso verde está encendido, se puede abrir la puerta.		
☞ Con la puerta abierta, vuelva a introducir el código maestro + 		
☞ Introduzca "17" + 		
☞ Introduzca "1" +  La función está activada.		

Repetición del código después del retardo



3.6.2 Desactivación de la repetición del código después del retardo

	Luz naranja	Luz verde
☞ Introduzca el código maestro + 		
☞ Cuando el indicador luminoso verde está encendido, se puede abrir la puerta.		
☞ Con la puerta abierta, vuelva a introducir el código maestro + 		
☞ Introduzca "17" + 		
☞ Introduzca "0" +  La función está desactivada.		



3.7 Señal sonora

Es posible elegir que su cerradura funcione en modo silencioso (zumbador neutralizado).

3.7.1 Activación de la señal sonora

	Luz naranja	Luz verde
Introduzca el código maestro +		
Cuando el indicador luminoso verde está encendido, se puede abrir la puerta.		
Con la puerta abierta, vuelva a introducir el código maestro +		
Introduzca "10" +		
Introduzca "1" + La función está activada.		



Atención, el uso de la cerradura en modo silencioso es menos intuitivo, y por lo tanto se pueden producir errores en su manejo. Se reserva entonces esta función para los usuarios que conozcan bien la cerradura.



3.7.2 Desactivación de la señal sonora

	Luz naranja	Luz verde
Introduzca el código maestro +		
Cuando el indicador luminoso verde está encendido, se puede abrir la puerta.		
Con la puerta abierta, vuelva a introducir el código maestro +		
Introduzca "10" +		
Introduzca "0" + La función está desactivada.		



Sólo las alarmas permanecen audibles cuando la señal sonora está desactivada (véase el apartado Diagnóstico de averías).



4. Función de auditoría de las cerraduras

Si ha comprado una cerradura con la función Audit, esta cerradura conserva en memoria (y de manera permanente) hasta 500 eventos.

Para poder leer los eventos contenidos en la cerradura, se debe disponer de la caja de recuperación BTXN, del cable de conexión con un PC y del software XN_Tool que permite la lectura de los datos.

La caja BTXN permite administrar la recuperación de eventos hasta en 16 cerraduras.

Todos estos elementos están disponibles como opción (póngase en contacto con su vendedor).



5. Diagnóstico de averías

- **El indicador luminoso naranja parpadea lentamente una decena de veces.**
 - ⇒ La pila de su cerradura está descargada: se le debe reemplazar.
- **El indicador luminoso naranja parpadea tres veces después de que se hubiera pulsado una tecla.**
 - ⇒ La cerradura está bloqueada por códigos falsos (introducción de al menos 3 códigos erróneos sucesivos): espere el final de la temporización de bloqueo antes de efectuar un nuevo intento (véase el capítulo 2.3).
- **El indicador luminoso naranja parpadea con una señal sonora de dos tonos.**
 - ⇒ El mecanismo de apertura está bloqueado: póngase en contacto con nuestro Servicio de Asistencia Técnica.
- **La cerradura emite una señal sonora larga después de que se hubiera pulsado una tecla.**
 - ⇒ El Teclado está abierto: esta señal desaparecerá en la próxima apertura de la cerradura.
- **Los indicadores verde y naranja parpadean simultáneamente y la cerradura emite una señal sonora de dos “bips”.**
 - ⇒ La comunicación entre el Teclado y la unidad de seguridad (en el interior del equipo de seguridad) no se establece correctamente: póngase en contacto con nuestro Servicio de Asistencia Técnica.

6. Garantía

Si fuere necesario, el vendedor de su equipo de seguridad es la primera persona autorizada para intervenir.

Consulte nuestro departamento Postventa que le comunicará la dirección de un profesional cualificado depositario de la marca e instalado cerca de usted.

En caso de intervención en su aparato, exija del departamento Postventa piezas de repuesto certificadas por el constructor.

Al llamar al departamento Postventa, indique el modelo y el número de matrícula de su equipo de seguridad.



No podemos ser responsables en caso de que aparezca un problema en una cerradura modificada o para la que no se hubiere utilizado piezas originales.



7. Ajustes de fábrica

Ajuste por defecto de fábrica

		Código de apertura por defecto	
Configuración del código	Maestro	000000	Activado
	Operador 1	111111	Desactivado
	Operador 2	222222	Desactivado
	Operador 3	333333	Desactivado
	Operador 4	444444	Desactivado
	Operador 5	555555	Desactivado
	Operador 6	666666	Desactivado
	Operador 7	777777	Desactivado
	C.I.T.	888888	Desactivado

Retardo	Retardo código de maestro	0 min
	Retardo código de operador	0 min
	Retardo en el procedimiento bajo coacción	0 min

Ajuste	Señal sonora	Activado
	Modo cuatro ojos	Desactivado
	Cable relé	Desactivado
	Procedimiento bajo coacción	Desactivado
	Introducción del código después de un retardo	Activado



8. Especificaciones técnicas

Las características eléctricas de la Combinación **Nectra** son las siguientes:

Fuente de alimentación:

Una pila alcalina de 9 voltios /
550 mA tipo 6LR61
Una fuente de alimentación externa

Tensión de alimentación:

de 8 a 18 voltios

Consumo:

18 μ A en reposo
4.5 mA al reactivarse
300 mA cuando gira el motor

Fuerza que puede ejercer el componente de cierre

10 N con alimentación de 9 V DC.

Materiales de la unidad de almacenamiento a los que puede ir fijada la cerradura

Materiales metálicos o compuestos resistentes al enroscado y al apriete.

Dimensiones de los orificios de las cerraduras, varillas o pasos de cables

Orificio de paso del cable que conecta la unidad de seguridad al terminal: Orificio redondo de 5 a 13 mm de diámetro.

Dimensiones mecánicas:

Terminal:

D = 90 mm
Al = 35 mm

Unidad de seguridad:

An = 87 mm
Al = 61 mm
P = 36 mm

Entorno:

**Temperatura de funcionamiento:
de -10 a +55°C**

**Humedad relativa:
de 20 a 80 %**

Recomendaciones relativas a la protección de las cerraduras contra el forcejeo destructivo

El orificio de paso del cable que conecta la unidad de seguridad al terminal debe estar desplazado respecto a la posición de la unidad de seguridad.

Instalación de los contactos de los pestillos







Los contactos de los pestillos son microinterruptores idealmente situados directamente en las piezas de cerrajería o, si no, en la parte móvil del varillaje.

El contacto del microinterruptor debe estar oprimido cuando la caja está cerrada.

INHALT

1. Einleitung	76
1.1 Produktbeschreibung	76
1.2 Signalgebung	77
1.3 Zugangsebenen der Benutzer	77
1.4 Öffnungscodes.....	77
2. Verwendung des Schlosses	78
2.1 Spannungsversorgung	78
2.2 Einlegen der Batterie	78
2.3 Öffnen der Tür.....	79
2.4 Sicherung der Tür	80
3. Einstellen des Systems (für fortgeschrittene Benutzer)	81
3.1 Ändern eines Öffnungscodes.....	81
3.2 Aktivieren und Deaktivieren eines Benutzers	82
3.3 Einstellen der Verzögerungen	84
3.4 Dual-Modus (Vier-Augen-Modus)	86
3.5 Alarmauslösung bei Bedrohung	88
3.6 Erneute Eingabe des Codes nach Verzögerung	91
3.7 Akustisches Signal	93
4. Auditfunktion des Schlosses	95
5. Fehlerdiagnose	96
6. Garantie	96
7. Werkseitige Einstellungen	97
8. Technische Spezifikationen	98

Signalgebung:

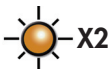
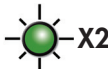
		Leuchtet nicht
		Leuchtet
		Blinkt
		Blinkt 2 Mal

1. Einleitung

Wir danken Ihnen für Ihren Kauf.

Mit diesem Schloss können Sie den Zugang zu Ihrem Besitz kontrollieren und sichern.

Das Schloss bietet mehrere Konfigurationsmöglichkeiten, die wir Ihnen in diesem Manual ausführlich beschreiben.

1.1 Produktbeschreibung

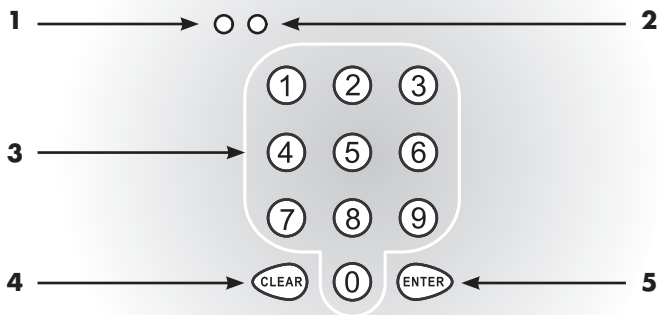

1 - Orange Kontrollleuchte.

2 - Grüne Kontrollleuchte.

3 - Tastenfeld: Die Betätigung einer Taste wird durch einen Signalton bestätigt.

4 - **"Clear"**-Taste: Nach Betätigung dieser Taste kann das Schloss manuell verriegelt und jegliche Code-Eingabe gelöscht werden.

5 - **"Enter"**-Taste: Taste zur Bestätigung der Eingabe.



1.2 Signalgebung

Jede richtige Aktion wird durch ein akustisches Signal (2 Pieptöne) und gleichzeitig durch zweimaliges Blinken der grünen Kontrollleuchte bestätigt.

Jede falsche Aktion wird durch ein akustisches Signal (3 Pieptöne) und gleichzeitig durch dreimaliges Blinken der orangen Kontrollleuchte bestätigt.

1.3 Zugangsebenen der Benutzer

Drei Zugangsebenen sind zulässig:

- 1 Master.
- 7 Benutzer.
- 1 C.I.T. (Geldtransport).

Nur mit dem Mastercode kann ein Code aktiviert, deaktiviert oder geändert werden. Das Schloss kann mit dem Mastercode, den Benutzercodes und dem C.I.T.-Code geöffnet werden.

Um Schwierigkeiten beim Öffnen durch einen vergessenen Code zu vermeiden, empfehlen wir Ihnen, mindestens zwei Öffnungscodes zu aktivieren.

1.4 Öffnungscodes

Ein Öffnungscodes kann sich aus 6, 7 oder 8 Ziffern zusammen setzen.

Die verschiedenen Defaultcodes finden Sie in Kapitel 7: "Werkseitige Einstellungen".



Verwenden Sie für optimale Sicherheit keine Codes wie beispielsweise: 000000....999999, 1234567, 7654321, usw.

2. Verwendung des Schlosses

2.1 Spannungsversorgung

Das Schloss kann wie folgt versorgt werden:

- Batterie (autonomer Betrieb).
- externe Spannungsversorgung (optional erhältlich, empfohlen bei intensiver Nutzung oder bei der Einstellung von Verzögerungszeiten).

2.2 Einlegen der Batterie

Wenn die orange Kontrollleuchte blinkt, ist Ihre Batterie entladen und muss ausgewechselt werden:

- ☞ Drehen Sie die Eingabeeinheit gegen den Uhrzeigersinn.
- ☞ Nehmen sie die Tastatur von der Eingabeeinheit ab.
- ☞ Schließen Sie die neue Batterie an und legen Sie sie ein (verwenden Sie eine 9V-Alkalibatterie 6LR61).
- ☞ Sobald die Batterie angeschlossen ist, muss dieser Vorgang von dem Schloss durch 2 Pieptöne bestätigt werden.
- ☞ Schließen Sie die Eingabeeinheit wieder (achten Sie dabei darauf, die Kabel nicht einzuklemmen) und befestigen Sie sie durch Drehen im Uhrzeigersinn.
- ☞ Ein 3 Sekunden langes akustisches Signal ertönt bei jedem Aufwecken des Schlosses (das Aufwecken erfolgt bei jeder Betätigung einer Taste nach mindestens 10 Sekunden langer Inaktivität), solange kein kompletter Öffnungsvorgang durchgeführt wurde.

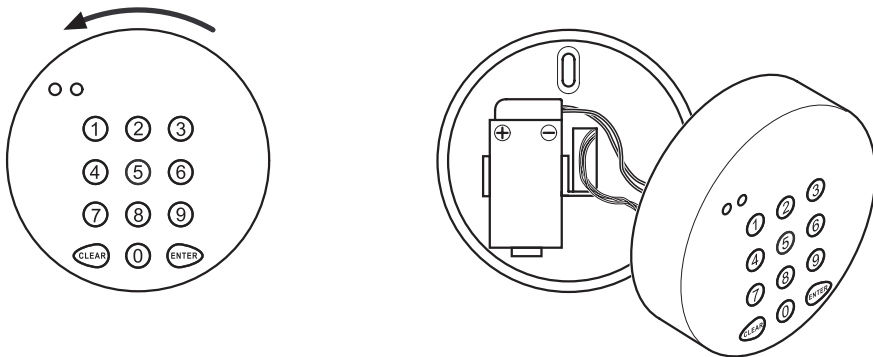

Die Codes, Einstellungen und Blockaden werden gespeichert und gegen Spannungsunterbrechungen gesichert.

Öffnen der Tür









F

GB











2.3 Öffnen der Tür

Je nach Einstellung des Schlosses, kann dieses auf verschiedene Arten geöffnet werden:

2.3.1 Öffnen ohne Verzögerung	Orange Leuchte	Grüne Leuchte
 Geben Sie einen Öffnungscode +  ein und warten Sie, bis die grüne Leuchte blinkt.		
 Wenn die grüne Kontrollleuchte leuchtet, können Sie die Tür öffnen.		

E

D

2.3.2 Öffnen mit Verzögerung	Orange Leuchte	Grüne Leuchte
 Geben Sie einen Öffnungscode +  ein und warten Sie, bis die orange und die grüne Leuchte blinken.		
 Wenn das Schloss Pieptöne abgibt, geben Sie Ihren Code nochmals ein.		
 Wenn die grüne Kontrollleuchte leuchtet, können Sie die Tür öffnen.		

I

P

NL

Blockierung bei falschem Code:

- Wenn Sie drei fehlerhafte Codes eingeben, wird das Schloss 10 Minuten lang blockiert.
- Wenn Sie einen vierten fehlerhaften Code eingeben, wird das Schloss 20 Minuten lang blockiert.
- Nach jedem weiteren fehlerhaften Versuch wird das Schloss 30 Minuten lang blockiert.











- Bei Eingabe eines C.I.T.-Codes wird das Schloss stets ohne Verzögerung geöffnet.
- Nach dem ersten Öffnen muss der werkseitig eingestellte Code durch einen sichereren Code ersetzt werden.













Öffnen der Tür







2.3.3 Öffnen der Tür im Dual-Modus (Vier-Augen-Modus) ohne Verzögerung

	Orange Leuchte	Grüne Leuchte
☞ Geben Sie einen Öffnungscode ein + 		 X2
☞ Wenn das Schloss Pieptöne abgibt, geben Sie dem zweiten Öffnungscode ein + 		
☞ Wenn die grüne Kontrollleuchte leuchtet, können Sie die Tür öffnen.		

2.3.4 Öffnen der Tür im Dual-Modus (Vier-Augen-Modus) mit Verzögerung

	Orange Leuchte	Grüne Leuchte
☞ Geben Sie einen Öffnungscode ein + 		 X2
☞ Wenn das Schloss Pieptöne abgibt, geben Sie dem zweiten Öffnungscode ein + 		
☞ Wenn das Schloss Pieptöne abgibt, geben Sie den zweiten Öffnungscode nochmals ein + 		
☞ Wenn die grüne Kontrollleuchte leuchtet, können Sie die Tür öffnen.		

2.4 Sichern der Tür

	Orange Leuchte	Grüne Leuchte
☞ Schließen Sie die Tür und verriegeln Sie sie.		
☞ Die Tür wird automatisch gesichert.		

Anmerkung: Wenn die Tür nicht geöffnet wurde,

betätigen Sie die Taste , um das Schloss zu verriegeln und die Tür zu sichern.

Ändern eines Codes



F

GB

E

D

I

P

NL

3. Einstellen des Systems (für fortgeschrittene Benutzer)

Wir empfehlen Ihnen, die Einstellungen stets bei geöffneter Tür zu ändern.

3.1 Ändern eines Öffnungscodes

	Orange Leuchte	Grüne Leuchte
Geben Sie den Mastercode ein +		
Wenn die grüne Kontrollleuchte leuchtet, können Sie die Tür öffnen		
* Geben Sie den Mastercode bei geöffneter Tür erneut ein +		
Wählen Sie durch folgende Eingabe (9 Möglichkeiten) einen Benutzer: - "0" + für den Mastercode. oder - "1" + für den Benutzer 1. . oder . - "7" + für den Benutzer 7. oder - "8" + für den Benutzer C.I.T.		
Geben Sie den neuen Code ein +		-X2
Geben Sie den neuen Code erneut ein +		-X2

Wenn Sie die Einstellung eines weiteren Parameters ändern möchten, wiederholen Sie den Vorgang ab*



- Ein Zugangscode kann sich aus 6, 7 oder 9 Ziffern zusammensetzen.
- Ein Code kann auch dann geändert werden, wenn der entsprechende Benutzer nicht aktiviert ist.

Aktivieren und Deaktivieren eines Benutzers



3.2 Aktivieren und Deaktivieren eines Benutzers

3.2.1 Aktivieren eines Benutzers

	Orange Leuchte	Grüne Leuchte
Geben Sie den Mastercode ein +		
Wenn die grüne Kontrollleuchte leuchtet, können Sie die Tür öffnen		
* Geben Sie den Mastercode bei geöffneter Tür erneut ein +		
Geben Sie "9" ein +		X2
Wählen Sie durch folgende Eingabe (8 Möglichkeiten) einen Benutzer: - "1" + für den Benutzer 1. oder - "2" + für den Benutzer 2. : oder : - "7" + für den Benutzer 7. oder - "8" + für den Benutzer C.I.T.		X2
Geben Sie "1" ein + Der Benutzer ist nun aktiviert.		X2

Wenn Sie die Einstellung eines weiteren Parameters ändern möchten, wiederholen Sie den Vorgang ab*



Ersetzen Sie den Defaultcode nach der ersten Aktivierung eines Benutzers durch einen sichereren Code.

Aktivieren und Deaktivieren eines Benutzers



F

GB

E



















D

I

P

NL

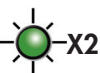
3.2.2 Deaktivieren eines Benutzers

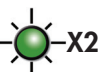
	Orange Leuchte	Grüne Leuchte
☞ Geben Sie den Mastercode ein + 		
☞ Wenn die grüne Kontrollleuchte leuchtet, können Sie die Tür öffnen		
*☞ Geben Sie den Mastercode bei geöffneter Tür erneut ein + 		
☞ Geben Sie "9" ein + 		
☞ Wählen Sie durch folgende Eingabe (8 Möglichkeiten) einen Benutzer: - "1" +  für den Benutzer 1. oder - "2" +  für den Benutzer 2. ⋮ oder ⋮ - "7" +  für den Benutzer 7. oder - "8" +  für den Benutzer C.I.T.		
☞ Geben Sie "0" ein +  Der Benutzer ist nun deaktiviert.		

Wenn Sie die Einstellung eines weiteren Parameters ändern möchten, wiederholen Sie den Vorgang ab *



Ein deaktivierter Code kann zwar nicht mehr zum Öffnen der Tür verwendet werden, bleibt aber dennoch gespeichert.

Einstellen der Verzögerungen















3.3 Einstellen der Verzögerungen

Das Schloss lässt die Einstellung einer Verzögerung beim Öffnen zu. Wenn Sie also Ihren Öffnungscod eingeben, müssen Sie die eingegebene Verzögerungszeit abwarten, bevor das Schloss entriegelt wird.

Die Dauer der Verzögerung kann zwischen "0" und "99" Minuten betragen.

3.3.1 Verzögerung Master

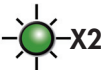
	Orange Leuchte	Grüne Leuchte
👉 Geben Sie den Mastercode ein + 		
👉 Wenn die grüne Kontrollleuchte leuchtet, können Sie die Tür öffnen		
👉 Geben Sie den Mastercode bei geöffneter Tür erneut ein + 		
👉 Geben Sie "13" ein + 		
👉 Geben Sie die "Verzögerungszeit in Minuten" ein + 		





















Bei häufiger Verwendung des Schlosses mit Verzögerung empfehlen wir Ihnen, Ihr Schloss an eine externe 12V-Spannungsquelle (optional erhältlich) anzuschließen.

Einstellen der Verzögerungen



3.3.2 Verzögerung Benutzer

	Orange Leuchte	Grüne Leuchte
 Geben Sie den Mastercode ein + 		
 Wenn die grüne Kontrollleuchte leuchtet, können Sie die Tür öffnen		
 Geben Sie den Mastercode bei geöffneter Tür erneut ein + 		
 Geben Sie "14" ein + 		
 Geben Sie die "Verzögerungszeit in Minuten" ein + 		



Bei häufiger Verwendung des Schlosses mit Verzögerung empfehlen wir Ihnen, Ihr Schloss an eine externe 12V-Spannungsquelle (optional erhältlich) anzuschließen.



















Dual-Modus (Vier-Augen-Modus)

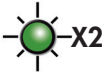

3.4 Dual-Modus (Vier-Augen-Modus)

Im Dual-Modus müssen 2 Benutzercodes eingegeben werden, um das Schloss öffnen zu können.

3.4.1 Dual-Modus (Vier-Augen-Modus) aktivieren

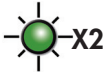
	Orange Leuchte	Grüne Leuchte
 Geben Sie den Mastercode ein + 		
 Wenn die grüne Kontrollleuchte leuchtet, können Sie die Tür öffnen		
 Geben Sie den Mastercode bei geöffneter Tür erneut ein + 		
 Geben Sie "12" ein + 		
 Geben Sie "1" ein +  Die Funktion ist nun aktiviert.		



Auch im Dual-Modus (Vier-Augen-Modus) kann die Tür mit dem Mastercode oder mit dem C.I.T.-Code alleine entriegelt werden.





















Im Dual-Modus (Vier-Augen-Modus) wird die für den zweiten eingegebenen Code eingestellte Verzögerungszeit angewendet.

Dual-Modus (Vier-Augen-Modus)

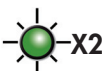

3.4.2 Dual-Modus (Vier-Augen-Modus) deaktivieren

	Orange Leuchte	Grüne Leuchte
 Geben Sie den Mastercode ein + 		
 Wenn die grüne Kontrollleuchte leuchtet, können Sie die Tür öffnen		
 Geben Sie den Mastercode bei geöffneter Tür erneut ein + 		
 Geben Sie "12" ein + 		
 Geben Sie "0" ein +  Die Funktion ist nun deaktiviert.		

F

GB

E

D

I

P

NL

Alarmauslösung bei Bedrohung

















3.5 Alarmauslösung bei Bedrohung

Für den Fall, dass Sie bei der Eingabe Ihres Codes bedroht werden, können Sie mit Hilfe dieser Funktion das Schloss mit einer besonderen Verzögerung entriegeln und/oder einen Alarm auslösen, um das Sicherheitspersonal zu warnen.

Die Alarmauslösung bei Bedrohung wird aktiviert, wenn Sie die letzte Ziffer des Codes um +/-1 ändern.

Beispiele: 156754 → 156753 oder 156755.
142789 → 142788 oder 142780.

3.5.1 Alarmauslösung bei Bedrohung aktivieren

	Orange Leuchte	Grüne Leuchte
☞ Geben Sie den Mastercode ein + 		
☞ Wenn die grüne Kontrollleuchte leuchtet, können Sie die Tür öffnen		
☞ Geben Sie den Mastercode bei geöffneter Tür erneut ein + 		
☞ Geben Sie "11" ein + 		
☞ Geben Sie "1" ein +  Die Funktion ist nun aktiviert.		





















Die Alarmauslösung bei Bedrohung erfordert einen Anschluss Ihres Schlosses an eine Alarmzentrale, die mit einem Fernüberwachungssystem verbunden ist.

Alarmauslösung bei Bedrohung



3.5.2 Alarmauslösung bei Bedrohung deaktivieren

	Orange Leuchte	Grüne Leuchte
 Geben Sie den Mastercode ein + 		
 Wenn die grüne Kontrollleuchte leuchtet, können Sie die Tür öffnen		
 Geben Sie den Mastercode bei geöffneter Tür erneut ein + 		
 Geben Sie "11" ein + 		
 Geben Sie "0" ein +  Die Funktion ist nun deaktiviert.		

F

GB

E

D

I

P













NL

Alarmauslösung bei Bedrohung



3.5.3 Verzögerung der Alarmauslösung bei Bedrohung

Die Verzögerungszeit kann zwischen "0" und "99" Minuten betragen.

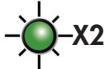
	Orange Leuchte	Grüne Leuchte
☞ Geben Sie den Mastercode ein + 		
☞ Wenn die grüne Kontrollleuchte leuchtet, können Sie die Tür öffnen		
☞ Geben Sie den Mastercode bei geöffneter Tür erneut ein + 		
☞ Geben Sie "15" ein + 		
☞ Geben Sie die "Verzögerungszeit in Minuten" ein + 		



Wenn der Dual-Modus (Vier-Augen-Modus) aktiviert ist, kann nur der zweite Benutzer die Verzögerung der Alarmauslösung bei Bedrohung aktivieren.

















3.6 Erneute Eingabe des Codes nach Verzögerung

Wenn Sie an Ihrem Schloss eine Verzögerung vor dem Öffnen eingestellt haben, können Sie wählen, ob Ihr Code nach Ablauf der Verzögerungszeit nochmals eingegeben werden muss, bevor die Tür entriegelt wird, oder nicht.

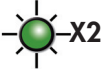
Defaultmäßig ist die erneute Eingabe des Codes aktiviert, siehe **Kapitel 7: "Werkseitige Einstellungen"**.



















3.6.1 Erneute Eingabe des Codes nach Verzögerung aktivieren

	Orange Leuchte	Grüne Leuchte
☞ Geben Sie den Mastercode ein + 		
☞ Wenn die grüne Kontrollleuchte leuchtet, können Sie die Tür öffnen		
☞ Geben Sie den Mastercode bei geöffneter Tür erneut ein + 		
☞ Geben Sie "17" ein + 		
☞ Geben Sie "1" ein +  Die Funktion ist nun aktiviert.		

Erneute Eingabe des Codes nach Verzögerung

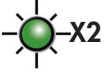

3.6.1 Erneute Eingabe des Codes nach Verzögerung deaktivieren













	Orange Leuchte	Grüne Leuchte
 Geben Sie den Mastercode ein + 		
 Wenn die grüne Kontrollleuchte leuchtet, können Sie die Tür öffnen		
 Geben Sie den Mastercode bei geöffneter Tür erneut ein + 		
 Geben Sie "17" ein + 		
 Geben Sie "0" ein +  Die Funktion ist nun deaktiviert.		



3.7 Akustisches Signal

Sie können sich dafür entscheiden, Ihr Schloss in Stummschaltung zu verwenden (Summer ausgeschaltet).

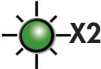
3.7.1 Akustisches Signal aktivieren

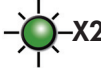
	Orange Leuchte	Grüne Leuchte
☞ Geben Sie den Mastercode ein + 		
☞ Wenn die grüne Kontrollleuchte leuchtet, können Sie die Tür öffnen		
☞ Geben Sie den Mastercode bei geöffneter Tür erneut ein + 		
☞ Geben Sie "10" ein + 		
☞ Geben Sie "1" ein +  Die Funktion ist nun aktiviert.		





















Vorsicht - Wir möchten Sie darauf aufmerksam machen, dass die Bedienung des Schlosses in Stummschaltung weniger intuitiv ist. Diese Funktion sollte daher Benutzern vorbehalten bleiben, die mit der Funktionsweise des Schlosses sehr gut vertraut sind.

Akustisches Signal



3.7.2 Akustisches Signal deaktivieren

	Orange Leuchte	Grüne Leuchte
 Geben Sie den Mastercode ein + 		
 Wenn die grüne Kontrollleuchte leuchtet, können Sie die Tür öffnen		
 Geben Sie den Mastercode bei geöffneter Tür erneut ein + 		
 Geben Sie "10" ein + 		
 Geben Sie "0" ein +  Die Funktion ist nun deaktiviert.		



Wenn das akustische Signal deaktiviert ist, bleiben nur die Alarmer hörbar (siehe Fehlerdiagnose).



4. Auditfunktion des Schlosses

Wenn Sie eine Ausführung mit Auditfunktion erworben haben, ist dieses Schloss in der Lage, bis zu 500 Ereignisse (dauerhaft) zu speichern.

Um diese im Schloss gespeicherten Ereignisse lesen zu können, müssen Sie über eine BTXN Ereignisabfrageeinheit, ein Anschlusskabel für den PC und die Datenauswertungssoftware XN_Tool verfügen.

Über die BTXN-Einheit können Sie die Ereignisabfrage für 16 Schlösser verwalten.

All diese Elemente sind optional erhältlich. Wenden Sie sich bitte an Ihren Händler.



5. Fehlerdiagnose

- **Die orange Kontrollleuchte blinkt ca. 10 Mal langsam.**

➔ Die Batterie in Ihrem Schloss ist leer. Bitte wechseln Sie die Batterie aus.

- **Die orange Kontrollleuchte blinkt nach Betätigung einer Taste drei Mal.**

➔ Das Schloss wurde nach Eingabe eines fehlerhaften Codes blockiert (es wurden mindestens 3 fehlerhafte Codes in Folge eingegeben). Warten Sie, bis die Verzögerungszeit der Blockierung abgelaufen ist und unternehmen Sie dann einen neuen Versuch (siehe Kapitel 2.3).

- **Die orange Kontrollleuchte blinkt und gleichzeitig ertönt ein Zweitonsignal.**

➔ Der Öffnungsmechanismus ist gestört. Wenden Sie sich bitte an Ihren Händler.

- **Das Schloss gibt nach Betätigung einer Taste einen langen Signalton ab.**

➔ Die Eingabeeinheit wurde geöffnet. Das Signal verschwindet beim nächsten Öffnen.

- **Die grüne und die orange Kontrollleuchte blinken gleichzeitig und das Schloss gibt ein akustisches Signal aus zwei Bieptönen ab.**

➔ Die Kommunikation zwischen der Eingabeeinheit und der Sicherheitseinheit (im Inneren des Gehäuses) kann nicht ordnungsgemäß hergestellt werden. Wenden Sie sich an Ihren Händler.

6. Garantie

Bei Bedarf ist der Händler, bei dem Sie das Gerät erworben haben, Ihr erster Ansprechpartner. Sollte es nicht möglich sein, Kontakt mit Ihrem Händler aufzunehmen (falls Sie umgezogen sein sollten oder das Geschäft, in dem Sie das Gerät erworben haben, geschlossen hat...), wenden Sie sich bitte an unseren Kundendienst, der Ihnen die Adresse eines zugelassenen Händlers der Marke in Ihrer Nähe mitteilt.

Sollte eine Reparatur an Ihrem Gerät erforderlich sein, dann bestehen Sie auf der Verwendung von vom Hersteller zugelassenen Ersatzteilen.

Legen Sie bitte die Modellnummer und die Seriennummer Ihres Geräts bereit, bevor Sie den Kundendienst anrufen.



Für Probleme, die an Schlössern auftreten, die verändert oder bei deren Reparatur keine

Originalteile verwendet wurden, können wir leider keine Haftung übernehmen.



7. Werkseitige Einstellungen

Defaulteinstellungen bei Verlassen des Werks

		Default-Öffnungscodes	
Einstellung des Codes	Master	000000	Aktiviert
	Benutzer 1	111111	Deaktiviert
	Benutzer 2	222222	Deaktiviert
	Benutzer 3	333333	Deaktiviert
	Benutzer 4	444444	Deaktiviert
	Benutzer 5	555555	Deaktiviert
	Benutzer 6	666666	Deaktiviert
	Benutzer 7	777777	Deaktiviert
	C.I.T.	888888	Deaktiviert

Verzögerung	Verzögerung Mastercode	0 min
	Verzögerung Benutzercode	0 min
	Verzögerung Alarmauslösung bei Bedrohung	0 min

Einstellung	Akustisches Signal	Aktiviert
	Vier-Augen-Modus	Deaktiviert
	Relaiskabel	Deaktiviert
	Alarmauslösung bei Bedrohung	Deaktiviert
	Erneute Eingabe des Codes nach Verzögerung	Aktiviert



8. Technische Spezifikationen

Die elektrischen Daten Ihres Kombinationsschlosses **Nectra** lauten wie folgt:

Stromversorgung:

Über eine Alkali-Batterie mit 9 Volt/
550 mAh Typ 6LR61

Über eine externe Stromversorgung

Versorgungsspannung:

8 volts bis 18 volts

Verbrauch:

18 μ A in Standby

4.5 mA im Wachzustand

300 mA bei drehendem Motor

Kraft, die die Verriegelungskomponente ausüben kann

10 N mit Stromversorgung 9 V DC.

Werkstoffe der Lagereinheit, auf der das Schloss befestigt werden kann

Metall oder Verbundstoffe, die Schrauben und Anziehen standhalten.

Abmessungen der Löcher der Schlösser, Stangen oder Kabeldurchführungen

Durchführung des Kabels, das die Sicherheitseinheit mit dem Terminal verbindet:
Rundes Loch mit einem Durchmesser von 5 mm bis 13 mm.

Physikalische Abmessungen:

Terminal:

D = 90 mm

H = 35 mm

Sicherheitseinheit:

L = 87 mm

H = 61 mm

P = 36 mm

Umgebung:

Betriebstemperatur:

-10 bis +55°C

Feuchtigkeit:

20 bis 80 %

Empfehlungen für den Schutz von Schlössern gegen zerstörerische Angriffe

Die Durchführung des Kabels, das die Sicherheitseinheit mit dem Terminal verbindet, muss in Bezug auf die Position der Sicherheitseinheit versetzt werden.

Installation der Kontakte des Riegels







Die Kontakte des Riegels sind Mikroschalter, die sich idealerweise direkt auf dem Schloss oder andernfalls auf dem mobilen Teil des Gestänges befinden.

Der Kontakt des Mikroschalters muss betätigt sein, wenn der Safe geschlossen ist.

INDICE

1. Introduzione	100
1.1 Descrizione del prodotto.....	100
1.2 Spie di segnalazione.....	101
1.3 Livello di accesso utenti.....	101
1.4 Codice di apertura.....	101
2. Uso della serratura	102
2.1 Alimentazione	102
2.2 Sostituzione pila	102
2.3 Apertura della serratura.....	103
2.4 Chiusura e blocco della serratura	104
3. Configurazione del sistema (utente avanzato)	105
3.1 Cambio codice di apertura	105
3.2 Attivare e disattivare gli operatori	106
3.3 Programmazione dei ritardi.....	108
3.4 Apertura Congiunta (Modo Dual).....	110
3.5 Procedura di apertura sotto costrizione.....	112
3.6 Ricomposizione del codice dopo ritardo.....	115
3.7 Segnale sonoro	117
4. Lettura e scarico eventi (solo per modello "audit")	119
5. Diagnostica dei guasti	120
6. Garanzia	120
7. Programmazione di fabbrica	121
8. Specifiche tecniche	122

Segnaletica:

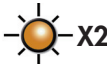
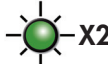
		Spento
		Acceso
		Lampeggiante
		Lampeggiante due volte

1. Introduzione

Grazie per il vostro acquisto.

Questa serratura permette di controllare e proteggere l'accesso ai vostri beni.

La serratura offre varie opzioni di configurazione.

1.1 Descrizione del prodotto

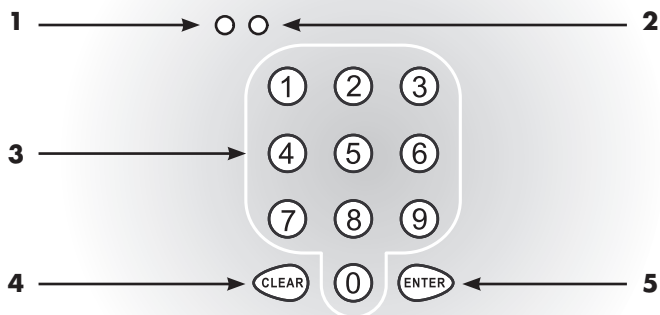

1 - Spia arancione.

2 - Spia verde.

3 - Tastiera: la pressione di un tasto è confermata da un bip sonoro.

4 - Tasto **"Clear"**: il tasto permette di bloccare manualmente la serratura e cancellare qualsiasi digitazione di codice.

5 - Tasto **"Enter"**: il tasto permette di convalidare il codice digitato.



1.2 Spie di segnalazione

Ogni azione corretta è confermata da un segnale sonoro composto da 2 bip associati a 2 lampeggi della spia verde.

Ogni azione errata è confermata da un segnale sonoro composto da 3 bip associati a tre lampeggi della spia arancione.

1.3 Livello di accesso utenti

Sono autorizzati tre livelli di accesso:

- 1 master.
- 7 operatori.
- 1 C.I.T (Portavalori).

Soltanto il codice master permette di attivare, disattivare o cambiare un codice. Il codice master, i codici operatori ed il codice C.I.T. permettono di aprire la serratura.

Per vostra sicurezza in caso di smarrimento del proprio codice, consigliamo di attivarne almeno due.

1.4 Codice di apertura

Un codice d'accesso può essere composto da 6, 7 o 8 cifre.

I vari codici di default sono consultabili nel capitolo 7: "Regolazione fabbrica".



Per una sicurezza ottimale, non usare codici come 000000....999999, 1234567, 7654321, ecc.

2. Uso della serratura

2.1 Alimentazione

La serratura può essere alimentata:

- mediante pila (uso autonomo).
- mediante alimentazione esterna (disponibile in opzione)

2.2 Sostituzione pila

Se la spia arancione lampeggia, la pila è scarica e deve essere cambiata.

In questo caso, dovete procedere come segue:

- ☞ Ruotare l'unità esterna in senso antiorario.
- ☞ Aprire l'unità.
- ☞ Togliere la vecchia pila e sostituirla con quella nuova (utilizzare una pila Alcalina 9 volt tipo 6LR6).
- ☞ Quando la pila è collegata, la serratura deve confermare l'operazione con 2 bip di conferma.
- ☞ Chiudere l'unità esterna ruotandola in senso orario, avendo cura di non schiacciare il cablaggio elettrico.
- ☞ Fino a quando non sarà eseguita un'apertura completa, la digitazione di un tasto dopo 10 secondi di inattività, provocherà l'emissione di un segnale sonoro per 3 secondi.

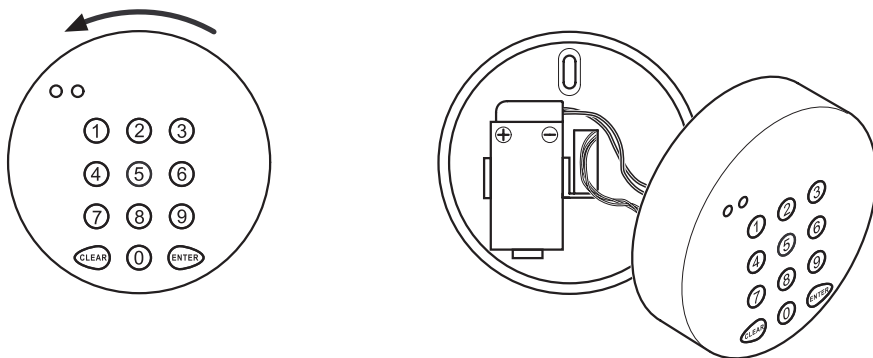

I codici, le programmazioni ed i blocchi rimangono memorizzati anche a seguito di mancanza alimentazione.







Apertura della serratura













2.3 Apertura della serratura

In funzione della programmazione, la serratura può essere aperta in vari modi:

2.3.1 Procedura di apertura senza ritardo

	Spia arancione	Spia verde
 Digitare un codice di apertura +  Attendere il lampeggio della spia verde.		
 La serratura sarà aperta quando la spia verde da lampeggiante diventerà fissa.		

2.3.2 Procedura di apertura con ritardo

	Spia arancione	Spia verde
 Digitare un codice di apertura +  Attendere il lampeggio delle spie arancione e verde.		
 Quando la serratura emette dei bip, digitare nuovamente il codice di apertura.		
 La serratura sarà aperta quando la spia verde da lampeggiante diventerà fissa.		

Blocco codice errato:

- In caso di digitazione di tre codici errati, la serratura sarà bloccata per 10 minuti.
- In caso di digitazione di un quarto codice errato, la serratura sarà bloccata per 20 minuti.
- Dopo qualsiasi nuovo tentativo, la serratura si bloccherà per 30 minuti.











- Il codice C.I.T. non è sottoposto a nessun ritardo.
- Dopo la prima apertura, il codice di fabbrica deve essere sostituito con un codice più sicuro.











Apertura della serratura







2.3.3 Procedura di apertura con 2 codici (modo dual) senza ritardo

	Spia arancione	Spia verde
☞ Digitare un codice di apertura + 		
☞ Quando la serratura emette dei bip, digitare un secondo codice di apertura + 		
☞ La serratura sarà aperta quando la spia verde da lampeggiante diventerà fissa.		

2.3.4 Procedura di apertura con 2 codici (modo dual) con ritardo

	Spia arancione	Spia verde
☞ Digitare un codice di apertura + 		
☞ Quando la serratura emette dei bip, digitare un secondo codice di apertura + 		
☞ Quando la serratura emette dei bip, digitare nuovamente il secondo codice di apertura + 		
☞ La serratura sarà aperta quando la spia verde da lampeggiante diventerà fissa.		

2.4 Chiusura e blocco della serratura

	Spia arancione	Spia verde
☞ Chiudere e bloccare il battente del mezzo forte.		
☞ La serratura è automaticamente bloccata.		

Nota: Se il battente del mezzo forte non viene aperto, premete il tasto  per bloccare la serratura e rendere sicuro il mezzo forte.



3. Configurazione del sistema (utente avanzato)

Vi consigliamo di eseguire le variazioni di configurazione e di testarne il funzionamento con il battente del mezzo forte aperto.

3.1 Cambio codice di apertura

	Spia arancione	Spia verde
☞ Digitare il codice master +		
☞ La serratura sarà aperta quando la spia verde da lampeggiante diventerà fissa.		
*☞ Con la serratura e la porta del mezzo forte aperta, digitare nuovamente il codice master +		
☞ Selezionare un utente (9 possibilità) digitando:		
<ul style="list-style-type: none"> - "0" + per il codice master. ○ - "1" + per l'operatore 1. ○ ⋮ - "7" + per l'operatore 7. ○ - "8" + per l'operatore C.I.T. 		
☞ Digitare il nuovo codice +		
☞ Digitare di nuovo il nuovo codice +		

Se volete modificare un altro parametro, dovete ripetere le operazioni a partire dal punto *



- Un codice di accesso può essere composto da 6, 7 o 8 cifre.
- Un codice può essere modificato anche se l'utente non è attivo.

Attivare e disattivare gli operatori



3.2 Attivare e disattivare gli operatori

3.2.1 Come attivare gli operatori

	Spia arancione	Spia verde
Digitare il codice master +		
La serratura sarà aperta quando la spia verde da lampeggiante diventerà fissa.		
* Con la serratura e la porta del mezzo forte aperta, digitare nuovamente il codice master +		
Digitare "9" +		
Selezionare un utente (8 possibilità) digitando:		
o - "1" + per l'operatore 1.	}	
o - "2" + per l'operatore 2.		
o .		
o - "7" + per l'operatore 7.		
o - "8" + per l'operatore C.I.T.		
Digitare "1" + L'operatore è attivato.		

Se volete modificare un altro parametro, dovete ripetere le operazioni a partire dal punto *



Dopo la prima attivazione di un operatore, sostituite il codice di fabbrica con un codice più sicuro.

Attivare e disattivare gli operatori



F

GB

E

D

I

P

NL

3.2.2 Come disattivare gli operatori

	Spia arancione	Spia verde
Digitare il codice master +		
La serratura sarà aperta quando la spia verde da lampeggiante diventerà fissa.		
* Con la serratura e la porta del mezzo forte aperta, digitare nuovamente il codice master +		
Digitare "9" +		
Selezionare un utente (8 possibilità) digitando: <ul style="list-style-type: none">- "1" + per l'operatore 1.○- "2" + per l'operatore 2.○○○- "7" + per l'operatore 7.○- "8" + per l'operatore C.I.T.		
Digitare "0" + L'operatore è disattivato.		

Se volete modificare un altro parametro, dovete ripetere le operazioni a partire dal punto*















Anche se un codice disattivato non autorizza l'apertura, quest'ultimo rimane comunque memorizzato.



3.3 Programmazione dei ritardi

NECTRA, permette la programmazione di tempi di ritardo d'apertura, in questo caso la digitazione del vostro codice provocherà l'attivazione della temporizzazione programmata, al termine della quale sarà possibile aprire il mezzo forte. La durata dei ritardi è compresa tra "0" e "99" minuti.

3.3.1 Ritardo master

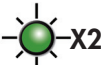
	Spia arancione	Spia verde
☞ Digitare il codice master + 		
☞ La serratura sarà aperta quando la spia verde da lampeggiante diventerà fissa.		
☞ Con la serratura e la porta del mezzo forte aperta, digitare nuovamente il codice master + 		
☞ Digitare "13" + 		
☞ Digitare "il ritardo in minuti" + 		



In caso di utilizzo intenso della serratura, vi consigliamo di collegarla ad un'alimentazione esterna 12V (disponibile in opzione).

Programmazione dei tempi di ritardo



3.3.2 Ritardo operatori

	Spia arancione	Spia verde
Digitare il codice master +		
La serratura sarà aperta quando la spia verde da lampeggiante diventerà fissa.		
Con la serratura e la porta del mezzo forte aperta, digitare nuovamente il codice master +		
Digitare "14" +		
Digitare "il ritardo in minuti" +		



In caso di utilizzo intenso della serratura, vi consigliamo di collegarla ad un'alimentazione esterna 12V (disponibile in opzione).

Apertura Congiunta (Modo Dual)



3.4 Apertura Congiunta (Modo Dual)

Nel Modo Dual, occorre comporre 2 codici operatori per poter sbloccare la serratura.

3.4.1 Come attivare il Modo Dual

	Spia arancione	Spia verde
Digitare il codice master +		
La serratura sarà aperta quando la spia verde da lampeggiante diventerà fissa.		
Con la serratura e la porta del mezzo forte aperta, digitare nuovamente il codice master +		
Digitare "12" +		X2
Digitare "1" + La funzione è così attivata.		X2



Anche in Modo Dual, il codice "Master" o il codice "C.I.T." da soli, autorizzano l'apertura della serratura.





















In Modo Dual, il ritardo applicato all'apertura è quello del secondo codice digitato.

Apertura Congiunta (Modo Dual)



3.4.2 Come disattivare il Modo Dual

	Spia arancione	Spia verde
 Digitare il codice master + 		
 La serratura sarà aperta quando la spia verde da lampeggiante diventerà fissa.		
 Con la serratura e la porta del mezzo forte aperta, digitare nuovamente il codice master + 		
 Digitare "12" + 		
 Digitare "0" +  La funzione è così disattivata.		

F

GB

E

D

I

P

NL

Procedura di apertura sotto costrizione



3.5 Procedura di apertura sotto costrizione















Nel caso di minaccia durante la digitazione del codice, la funzione "allarme sotto costrizione", vi permette di comandare l'apertura della serratura, applicando un ritardo specifico e/o attivando un allarme per avvertire gli addetti della sicurezza.

La procedura sotto costrizione si attiva cambiando l'ultima cifra del codice di (+/- 1).

Esempi: 156754 → 156753 o 156755.

142789 → 142788 o 142780.

3.5.1 Come attivare la procedura di allarme sotto costrizione

	Spia arancione	Spia verde
☞ Digitare il codice master + 		
☞ La serratura sarà aperta quando la spia verde da lampeggiante diventerà fissa.		
☞ Con la serratura e la porta del mezzo forte aperta, digitare nuovamente il codice master + 		
☞ Digitare "11" + 		
☞ Digitare "1" +  La funzione è così attivata.		

















L'attivazione di un allarme mediante uso della procedura sotto costrizione richiede la connessione della serratura ad una centrale d'allarme collegata ad un sistema di telesorveglianza.

Procedura di apertura sotto costrizione



3.5.2 Come disattivare la procedura di allarme sotto costrizione

	Spia arancione	Spia verde
☞ Digitare il codice master + 		
☞ La serratura sarà aperta quando la spia verde da lampeggiante diventerà fissa.		
☞ Con la serratura e la porta del mezzo forte aperta, digitare nuovamente il codice master + 		
☞ Digitare "11" + 		
☞ Digitare "0" +  La funzione è così disattivata.		

F

GB

E

D

I

P















NL

Procedura di apertura sotto costrizione



3.5.3 Come programmare il tempo di ritardo per allarme sotto costrizione

La durata dei ritardi è compresa tra "0" e "99" minuti.

	Spia arancione	Spia verde
☞ Digitare il codice master + 		
☞ La serratura sarà aperta quando la spia verde da lampeggiante diventerà fissa.		
☞ Con la serratura e la porta del mezzo forte aperta, digitare nuovamente il codice master + 		
☞ Digitare "15" + 		
☞ Digitare "il ritardo in minuti" + 		



In caso di attivazione del "Modo Dual" (apertura congiunta), soltanto il secondo utente può attivare il ritardo sotto costrizione.















3.6 Ricomposizione del codice dopo ritardo

In caso di programmazione di un ritardo d'apertura, potete scegliere di ricomporre il codice al termine della temporizzazione programmata.

La programmazione di fabbrica prevede che questa funzione sia attiva, Vedi **capitolo 7: "Programmazione di fabbrica"**.

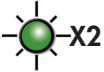

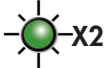











3.6.1 Come attivare la ricomposizione del codice dopo ritardo

	Spia arancione	Spia verde
☞ Digitare il codice master + 		
☞ La serratura sarà aperta quando la spia verde da lampeggiante diventerà fissa.		
☞ Con la serratura e la porta del mezzo forte aperta, digitare nuovamente il codice master + 		
☞ Digitare "17" + 		
☞ Digitare "1" +  La funzione è così attivata.		

Ricomposizione del codice dopo ritardo

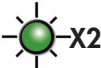

3.6.2 Come disattivare la ricomposizione del codice dopo ritardo

	Spia arancione	Spia verde
☞ Digitare il codice master + 		
☞ La serratura sarà aperta quando la spia verde da lampeggiante diventerà fissa.		
☞ Con la serratura e la porta del mezzo forte aperta, digitare nuovamente il codice master + 		
☞ Digitare "17" + 		
☞ Digitare "0" +  La funzione è così disattivata.		



3.7 Segnale sonoro

NECTRA, se opportunamente programmata, può funzionare in modalità silenziosa (buzzer disattivato).

3.7.1 Come attivare il buzzer



















	Spia arancione	Spia verde
Digitare il codice master +		
La serratura sarà aperta quando la spia verde da lampeggiante diventerà fissa.		
Con la serratura e la porta del mezzo forte aperta, digitare nuovamente il codice master +		
Digitare "10" +		
Digitare "1" + La funzione è così attivata.		



L'uso della serratura in modo silenzioso è meno intuitivo. Questa funzione, deve pertanto essere utilizzata con particolare attenzione.

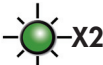

3.7.2 Come disattivare il buzzer

	Spia arancione	Spia verde
 Digitare il codice master + 		
 La serratura sarà aperta quando la spia verde da lampeggiante diventerà fissa.		
 Con la serratura e la porta del mezzo forte aperta, digitare nuovamente il codice master + 		
 Digitare "10" + 		
 Digitare "0" +  La funzione è così disattivata.		



Se il buzzer è disattivato, gli allarmi rimangono comunque udibili (vedi diagnostica dei guasti).



4. Lettura e scarico eventi (solo per modello "audit")

Questa funzione, è riservata alla serratura NECTRA modello "AUDIT" che è in grado di memorizzare in modo permanente fino a 500 eventi.

Per poter leggere gli eventi contenuti nella serratura, occorre disporre del dispositivo portatile di recupero dati "BXTN" e dell'apposito cavo di collegamento ad un PC dove deve essere installato il software applicativo "XN_TOOL" che permette la gestione dei dati.

Il dispositivo portatile "BXTN", permette di gestire il recupero degli eventi da un minimo di 1 fino ad un massimo di 16 serrature.

Tutti questi dispositivi, sono disponibili in opzione.



5. Diagnostica dei guasti

- **La spia arancione lampeggia lentamente una decina di volte.**
 - ⇒ La pila della serratura è scarica e deve essere sostituita.

- **La spia arancione lampeggia tre volte dopo la pressione di un tasto.**
 - ⇒ La serratura è bloccata a causa della digitazione di un codice errato (digitazione di almeno 3 codici errati successivi). Attendere la fine della temporizzazione di blocco prima di procedere ad un nuovo tentativo (vedi Capitolo 2.3).

- **La spia arancione lampeggia con un segnale sonoro due tonalità.**
 - ⇒ Il meccanismo d'apertura è bloccato. Contattare il servizio assistenza.

- **La serratura emette un lungo segnale sonoro dopo la pressione di un tasto.**
 - ⇒ L'unità di digitazione è stata aperta. Questo segnale scomparirà al momento dell'apertura successiva.

- **Le spie verde ed arancione lampeggiano contemporaneamente e la serratura emette un segnale sonoro composto da due bip.**
 - ⇒ La comunicazione tra l'unità esterna e l'unità di sicurezza installata all'interno della cassaforte non è stata correttamente stabilita. Contattare il servizio assistenza.

6. Garanzia

Secondo quanto esposto nelle condizioni di vendita.

In caso di richiesta di intervento tecnico, è bene indicare il modello, il numero di serie della vostra cassaforte e la data di acquisto.



Decliniamo qualsiasi responsabilità in caso di problemi dovuti alla modifica della serratura o al mancato utilizzo dei pezzi di ricambio originali.



7. Programmazione di fabbrica

Programmazione di fabbrica

		Codice di apertura di fabbrica	
Configurazione del codice	Master	000000	Attivato
	Operatore 1	111111	Disattivato
	Operatore 2	222222	Disattivato
	Operatore 3	333333	Disattivato
	Operatore 4	444444	Disattivato
	Operatore 5	555555	Disattivato
	Operatore 6	666666	Disattivato
	Operatore 7	777777	Disattivato
	C.I.T.	888888	Disattivato

Verzögerung	Ritardo codice master	0 min
	Ritardo codice operatore	0 min
	Ritardo procedura allarme sotto costrizione	0 min

Programmazione	Segnale sonoro	Attivato
	Apertura Congiunta (Modo Dual)	Disattivato
	Cavo relè	Disattivato
	Procedura allarme sotto costrizione	Disattivato
	Procedura allarme sotto costrizione	Attivato



8. Specifiche tecniche

Le caratteristiche elettroniche della Serratura a combinazione **Nectra** sono le seguenti:

Alimentazione:

Una pila alcalina 9 volt/
550 mA tipo 6LR61
Un'alimentazione esterna

Tensione di alimentazione:

da 8 a 18 volt

Consumo:

18 μ A in standby
4,5 mA alla ripresa
300 mA a motore acceso

Forza che può esercitare il componente di chiusura

10N con alimentazione a 9VDC.

Materiali dell'unità di stoccaggio su cui la serratura può essere fissata

Materiali metallici o compositi che resistono all'avvitamento e al serraggio.

Dimensioni dei fori delle serrature, aste o canaline per i cavi

Foro di passaggio del cavo che collega l'unità di sicurezza al terminale: Foro rotondo di diametro 5 mm a 13 mm.

Dimensioni meccaniche:

Terminale:

D = 90 mm
H = 35 mm

Unità di sicurezza:

L = 87 mm
H = 61 mm
P = 36 mm

Ambiente:

**Temperatura di funzionamento:
da -10 a +55°C**

**Umidità relativa:
dal 20 all'80 %**

Raccomandazioni relative alla protezione delle serrature contro gli attacchi distruttivi

Il foro di passaggio del cavo che collega l'unità di sicurezza al terminale deve essere sfasato rispetto alla posizione dell'unità di sicurezza.

Installazione di contatti catenacci

I contatti catenaccio sono microinterruttori situati preferibilmente direttamente sulle parti di ferramento o altrimenti sulla parte mobile della tiranteria.

Il contatto del microinterruttore deve essere premuto quando la cassaforte è chiusa.

ÍNDICE

1. Introdução.....	124
1.1 Descrição do equipamento	124
1.2 Sinalização.....	125
1.3 Nível de acesso dos utilizadores.....	125
1.4 Código de abertura	125
2. Utilização da fechadura.....	126
2.1 Alimentação.....	126
2.2 Colocação da pilha	126
2.3 Abrir a porta.....	127
2.4 Segurança da porta	128
3. Configuração do sistema (utilizador avançado).....	129
3.1 Alteração de um código de abertura.....	129
3.2 Activar e desactivar os operadores	130
3.3 Programação dos retardamentos	132
3.4 Modo Dual (dois códigos).....	134
3.5 Procedimento sob coacção	136
3.6 Recomposição do código após retardamento.....	139
3.7 Sinal sonoro.....	141
4. Função audit das fechaduras	143
5. Diagnóstico de avarias	144
6. Garantia	144
7. Ajuste de fábrica	145
7. Especificações técnicas	146

Sinalética:

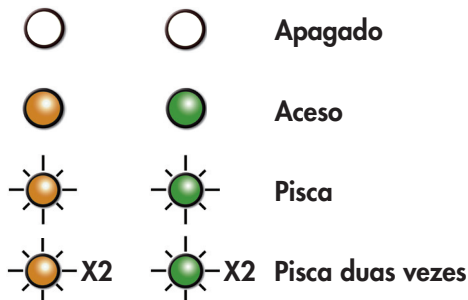

1. Introdução

Gratos pela sua compra.

Esta fechadura permite controlar e proteger o acesso aos seus bens.

A fechadura oferece várias opções de configuração.

1.1 Descrição do equipamento

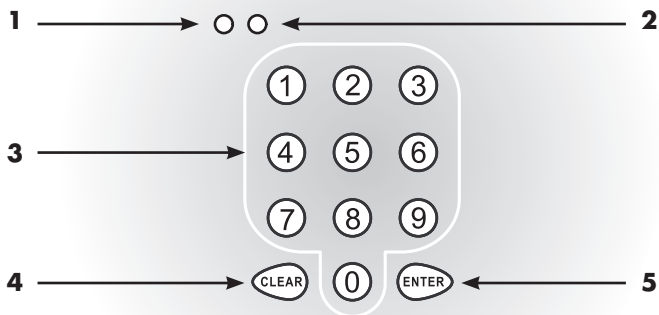

1 - Indicador de sinalização laranja.

2 - Indicador de sinalização verde.

3 - Teclado: a pressão de uma tecla é confirmada por um sinal sonoro.

4 - Tecla "**Clear**": esta tecla permite bloquear manualmente a fechadura e apagar qualquer digitação de códigos.

5 - Tecla "**Enter**": esta tecla permite validar a digitação.

1.2 Sinalização

Cada acção correcta é confirmada por um sinal sonoro composto por dois bips associados ao indicador verde, que se acende 2 vezes.

Cada acção incorrecta é confirmada por um sinal sonoro composto por 3 bips associados ao indicador laranja, que se acende três vezes.

1.3 Nível de acesso dos utilizadores

Estão autorizados três níveis de acesso:

- 1 mestre.
- 7 operadores.
- 1 C.I.T. (Transferência de fundos).

Apenas o código mestre pode activar, desactivar ou alterar um código. O código mestre, os códigos de operador e o código C.I.T. podem abrir a fechadura.

Prevendo a possibilidade de esquecimento do seu código, aconselhamos que disponha pelo menos de dois códigos de abertura activados.

1.4 Código de abertura

Um código de abertura pode ser composto por 6, 7 ou 8 algarismos.

Os diferentes códigos predefinidos podem ser consultados no capítulo 7: "Ajuste de fábrica".



Para uma segurança óptima, não utilize códigos do tipo: 000000....999999, 1234567, 7654321, etc.

2. Utilização da fechadura

2.1 Alimentação

A fechadura pode ser alimentada:

- por meio de pilha (utilização autónoma)
- por alimentação externa (disponível em opção, aconselhada para uma utilização intensiva ou para parametrização de retardamentos).

2.2 Colocação da pilha

Quando o indicador laranja pisca, a sua pilha encontra-se descarregada e deverá substituí-la:

- ↳ Rode a unidade de digitação no sentido anti-horário.
- ↳ Retire o teclado da unidade de digitação.
- ↳ Ligar e colocar a pilha na sua posição (utilize uma pilha Alcalina de 9 volts: tipo 6LR61).
- ↳ Quando a pilha é ligada, a fechadura deve confirmar a operação por meio de 2 bips de validação.
- ↳ Feche a unidade de digitação sem trilhar os cabos eléctricos e feche rodando no sentido horário.
- ↳ Um sinal sonoro de 3 segundos será emitido após cada reactivação da fechadura (a reactivação ocorre com a pressão duma tecla após pelo menos 10 segundos de inactividade da fechadura), se não tiver sido efectuada uma abertura completa.

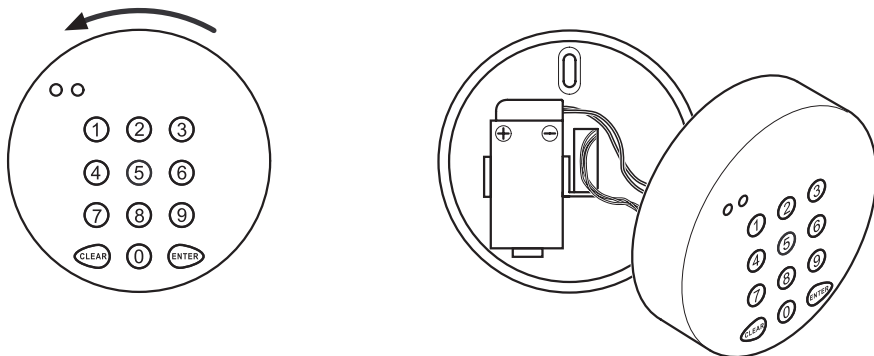







Os códigos, ajustes e bloqueios são guardados e protegidos contra faltas de energia.











2.3 Abrir a porta

Consoante a parametrização da fechadura, esta pode abrir-se de várias formas:

2.3.1 Abertura sem retardamento

	Indicador laranja	Indicador verde
 Digite um código de abertura +  e aguarde enquanto o indicador verde pisca.		
 Quando o indicador verde se ilumina, pode abrir a porta.		

2.3.2 Abertura com retardamento

	Indicador laranja	Indicador verde
 Digite um código de abertura +  e aguarde enquanto os indicadores laranja e verde piscam.		
 Quando a fechadura emite bips, digite de novo o seu código de abertura.		
 Quando o indicador verde se ilumina, pode abrir a porta.		

Bloqueio de código falso:



- Se digitar três códigos errados, a fechadura será bloqueada por 10 minutos.
- Se inserir um quarto código errado, o bloqueio durará 20 minutos.
- Após qualquer nova tentativa, a fechadura bloqueará durante 30 minutos.











- O código C.I.T. não é submetido a qualquer retardamento.
- Após a primeira abertura, o código de fábrica deve ser substituído por um código mais seguro.











Abertura da porta

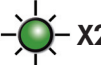





2.3.3 Abertura em Modo Dual (Dois Códigos) sem retardamento

	Indicador laranja	Indicador verde
☞ Digite um código de abertura + 		
☞ Quando a fechadura emite bips, digite de novo um segundo código de abertura + 		
☞ Quando o indicador verde se ilumina, pode abrir a porta.		

2.3.4 Abertura em Modo Dual (Dois Códigos) com retardamento

	Indicador laranja	Indicador verde
☞ Digite um código de abertura + 		
☞ Quando a fechadura emite bips, digite de novo um segundo código de abertura + 		
☞ Quando a fechadura emite bips, digite de novo o segundo código de abertura + 		
☞ Quando o indicador verde se ilumina, pode abrir a porta.		

2.4 Segurança da porta

	Indicador laranja	Indicador verde
☞ Fechar e trancar a porta.		
☞ A fechadura é trancada automaticamente.		

Nota: Se a porta não tiver sido aberta, prima  para trancar a fechadura e fechar a porta.



3. Configuração do sistema (utilizador avançado)

Aconselhamos a realização de qualquer alteração de configuração com a porta aberta.

3.1 Alteração de um código de abertura

	Indicador laranja	Indicador verde
☞ Digite o código mestre +		
☞ Quando o indicador verde se ilumina, pode abrir a porta.		
* ☞ Porta aberta, digite de novo o código mestre +		
☞ Seleccione um utilizador (9 possibilidades) digitando:		
<ul style="list-style-type: none"> ○ - "0" + para o código mestre. ○ - "1" + para o operador 1. <li style="text-align: center;">⋮ ○ - "7" + para o operador 7. ○ - "8" + para o operador C.I.T. 		
☞ Digite o novo código +		-X2
☞ Digite de novo o código +		-X2

Se pretender modificar outro parâmetro, retome as operações no ponto *



- Um código de acesso pode ser composto por 6, 7 ou 8 algarismos.
- Um código pode modificar-se até com o utilizador desactivado.

Activar e desactivar os operadores



3.2 Activar e desactivar os operadores

3.2.1 Activar os operadores

	Indicador laranja	Indicador verde
Digite o código mestre +		
Quando o indicador verde se ilumina, pode abrir a porta.		
* Porta aberta, digite de novo o código mestre +		
Digite "9" +		
Selecciona um utilizador (8 possibilidades) digitando:		
- "1" + para o operador 1.	}	
o - "2" + para o operador 2.		
o .		
o .		
- "7" + para o operador 7.		
o - "8" + para o operador C.I.T.		
Digite "1" + O operador está activado.		

Se pretender modificar outro parâmetro, retome as operações no ponto *



Após a primeira activação de um operador, substitua o código predefinido por um código mais seguro.

Activar e desactivar os operadores



3.2.2 Desactivar os operadores

	Indicador laranja	Indicador verde
Digite o código mestre +		
Quando o indicador verde se ilumina, pode abrir a porta.		
* Porta aberta, digite de novo o código mestre +		
Digite "9" +		
Seleccione um utilizador (8 possibilidades) digitando: <ul style="list-style-type: none">- "1" + para o operador 1.o- "2" + para o operador 2.oo- "7" + para o operador 7.o- "8" + para o operador C.I.T.		
Digite "0" + O operador está desactivado.		

Se pretender modificar outro parâmetro, retome as operações no ponto *



Mesmo que um código desactivado não autorize a abertura, o código permanece em memória.















3.3 Programação dos retardamentos

A fechadura permite a programação de um retardamento de abertura. Assim, quando digita o seu código de abertura, decorre o tempo programado da temporização antes de a fechadura ser destrancada.

A duração dos atrasos é de "0" a "99" minutos.

3.3.1 Retardamento código mestre

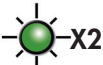

















	Indicador laranja	Indicador verde
☞ Digite o código mestre + 		
☞ Quando o indicador verde se ilumina, pode abrir a porta.		
☞ Porta aberta. digite de novo o código mestre + 		
☞ Digite "13" + 		
☞ Digite "o retardamento em minutos" + 		



Para uma utilização intensiva da fechadura com retardamento, aconselhamos a ligação da sua fechadura a uma fonte de alimentação externa de 12V (disponível em opção).

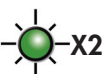

3.3.2 Retardamento do código dos operadores

	Indicador laranja	Indicador verde
 Digite o código mestre + 		
 Quando o indicador verde se ilumina, pode abrir a porta.		
 Porta aberta, digite de novo o código mestre + 		
 Digite "14" + 		
 Digite "o retardamento em minutos" + 		



Para uma utilização intensiva da fechadura com retardamento, aconselhamos a ligação da sua fechadura a uma fonte de alimentação externa de 12V (disponível em opção).



















Modo Dual (dois códigos)



3.4 Modo Dual (dois códigos)

No Modo Dual, é necessário digitar 2 códigos de operador para poder destrancar a fechadura.

3.4.1 Activar o Modo Dual (dois códigos)

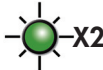
	Indicador laranja	Indicador verde
 Digite o código mestre + 		
 Quando o indicador verde se ilumina, pode abrir a porta.		
 Porta aberta, digite de novo o código mestre + 		
 Digite "12" + 		
 Digite "1" +  A função está activada.		



Mesmo no Modo Dual (dois códigos), o código mestre isolado ou o código C.I.T. isolado autoriza a abertura da porta.





















No Modo Dual (dois códigos), o retardamento aplicado á abertura é o do segundo código efectuado.

Modo Dual (dois códigos)

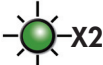

3.4.2 Desactivar o Modo Dual (dois códigos)

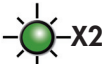
	Indicador laranja	Indicador verde
 Digite o código mestre + 		
 Quando o indicador verde se ilumina, pode abrir a porta.		
 Porta aberta, digite de novo o código mestre + 		
 Digite "12" + 		
 Digite "0" +  A função está desactivada.		

F

GB

E

D

I

P

NL















3.5 Procedimento sob coacção

No caso de ser ameaçado durante a digitação do seu código, a função de alarme sob coacção permite-lhe comandar a abertura da fechadura aplicando um retardamento específico e desencadeando um alarme para prevenir os agentes de segurança.

O procedimento sob coacção activa-se mudando o último algarismo do código +/- 1.

Exemplos: 156754 → 156753 o 156755.
142789 → 142788 o 142780.

3.5.1 Activar o procedimento sob coacção

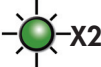
	Indicador laranja	Indicador verde
☞ Digite o código mestre + 		
☞ Quando o indicador verde se ilumina, pode abrir a porta.		
☞ Porta aberta, digite de novo o código mestre + 		
☞ Digite "11" + 		
☞ Digite "1" +  A função está activada.		

















O disparo de um alarme devido à utilização do procedimento sob coacção necessita de uma ligação da sua fechadura a uma central de alarme ligada a um sistema de vigilância por vídeo.

Procedimento sob coacção



3.5.2 Desactivar o procedimento sob coacção

	Indicador laranja	Indicador verde
☞ Digite o código mestre + 		
☞ Quando o indicador verde se ilumina, pode abrir a porta.		
☞ Porta aberta, digite de novo o código mestre + 		
☞ Digite "11" + 		
☞ Digite "0" +  A função está desactivada.		

F

GB

E

D















I

P

NL

3.5.3 Retardamento do procedimento sob coacção

A duração do Retardamento atrasos é de "0" a "99" minutos.

	Indicador laranja	Indicador verde
☞ Digite o código mestre + 		
☞ Quando o indicador verde se ilumina, pode abrir a porta.		
☞ Porta aberta, digite de novo o código mestre + 		
☞ Digite "15" + 		
☞ Digite "o retardamento em minutos" + 		



Quando o Modo Dual (dois códigos) está activado, apenas o segundo utilizador pode activar o retardamento sob coacção.

















3.6 Recomposição do código após retardamento

Depois de ter programado um retardamento de abertura na sua fechadura, pode optar pela necessidade de compor de novo, ou não, o seu código após a temporização, para obter a abertura da fechadura.

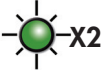
Por defeito, a recomposição do código encontra-se activada. Ver **capítulo 7: "Ajuste de fábrica"**.

3.6.1 Activar a recomposição do código após retardamento

	Indicador laranja	Indicador verde
☞ Digite o código mestre + 		
☞ Quando o indicador verde se ilumina, pode abrir a porta.		
☞ Porta aberta, digite de novo o código mestre + 		
☞ Digite "17" + 		
☞ Digite "1" +  A função está activada.		

Recomposição do código após retardamento



3.6.2 Desactivar a recomposição do código após retardamento

	Indicador laranja	Indicador verde
Digite o código mestre +		
Quando o indicador verde se ilumina, pode abrir a porta.		
Porta aberta, digite de novo o código mestre +		
Digite "17" +		
Digite "0" + A função está desactivada.		



3.7 Sinal sonoro

Pode optar por fazer funcionar a sua fechadura em modo silencioso (avisador sonoro neutralizado).

3.7.1 Activar o sinal sonoro



















	Indicador laranja	Indicador verde
Digite o código mestre +		
Quando o indicador verde se ilumina, pode abrir a porta.		
Porta aberta, digite de novo o código mestre +		
Digite "10" +		
Digite "1" + A função está activada.		



Atenção, chamamos a sua atenção para o facto de a utilização da fechadura em modo silencioso ser menos intuitivo, devendo portanto esta função ser reservada aos utilizadores com bastante experiência no funcionamento da fechadura.

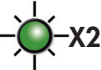

3.7.2 Desactivar o sinal sonoro

	Indicador laranja	Indicador verde
 Digite o código mestre + 		
 Quando o indicador verde se ilumina, pode abrir a porta.		
 Porta aberta, digite de novo o código mestre + 		
 Digite "10" + 		
 Digite "0" +  A função está desactivada.		



Apenas os alarmes permanecem activados quando o sinal sonoro é desactivado (ver Diagnóstico de avarias).



4. Função audit das fechaduras

Se tiver adquirido uma fechadura com a função Audit, essa fechadura conserva em memória (e de forma permanente) até 500 eventos.

Para poder efectuar a leitura dos eventos contidos na fechadura, é necessário dispor da caixa de recuperação BTXN, do cabo de ligação com um PC e da aplicação XN_Tool, que permite a exploração dos dados. A caixa BTXN permite gerir a recuperação dos eventos em 16 fechaduras.

Todos estes elementos estão disponíveis em opção (contacte o seu revendedor).

5. Diagnóstico de avarias

- **O indicador laranja pisca lentamente uma dezena de vezes.**
 - ⇒ A pilha da sua fechadura está descarregada: é necessário substituí-la.
- **O indicador laranja pisca três vezes depois de premir qualquer tecla.**
 - ⇒ A fechadura encontra-se bloqueada por código errado (digitação de pelo menos 3 códigos errados sucessivos); aguardar pelo final da temporização de bloqueio antes de proceder a uma nova tentativa (consultar o Capítulo 2.3).
- **O indicador laranja pisca com um sinal sonoro de dois tons.**
 - ⇒ O mecanismo de abertura está obstruído: contacte o seu revendedor.
- **A fechadura emite um longo sinal sonoro depois de premir qualquer tecla.**
 - ⇒ A unidade de digitação foi aberta: este sinal desaparecerá durante a próxima abertura.
- **Os indicadores verde e laranja piscam simultaneamente e a fechadura emite um sinal sonoro composto por dois bips.**
 - ⇒ A comunicação entre a unidade de digitação e a unidade de segurança (no interior do cofre) não foi estabelecida correctamente: contacte o seu revendedor.

6. Garantia

Em caso de necessidade, o vendedor do seu cofre é o primeiro habilitado a intervir. Em caso de falha (mudança da sua parte, encerramento ou aquisição de loja...), consulte o Serviço Após Venda, que lhe indicará o contacto de um profissional qualificado representante da marca junto de si.

Em caso de intervenção no seu aparelho, exija do Serviço Após venda as peças de substituição certificadas pelo construtor.

Quando contactar o Serviço Após Venda, indique o modelo e o número de matrícula do seu cofre.



Não nos responsabilizamos em caso de problema ocorrido numa fechadura modificada ou na qual não tenham sido utilizadas peças de origem.



7. Ajuste de fábrica

Ajuste predefinido de fábrica

		Código de abertura por defeito	
Configuração do código	Mestre	000000	Activado
	Operador 1	111111	Desactivado
	Operador 2	222222	Desactivado
	Operador 3	333333	Desactivado
	Operador 4	444444	Desactivado
	Operador 5	555555	Desactivado
	Operador 6	666666	Desactivado
	Operador 7	777777	Desactivado
	C.I.T.	888888	Desactivado

Retardamento	Retardamento do código mestre	0 min
	Retardamento do código do operador	0 min
	Retardamento do procedimento sob coacção	0 min

Regulação	Sinal sonoro	Activado
	Modo Dual (Dois Códigos)	Desactivado
	Cabo relé	Desactivado
	Procedimento sob coacção	Desactivado
	Recomposição do código após retardamento	Activado



8. Especificações técnicas

As características elétricas da combinação **Nectra** são as seguintes:

Alimentação:

Pilha alcalina de 9 volts/
550 mAh de tipo 6LR61
Uma alimentação externa

Tensão de alimentação:

entre 8 volts e 18 volts

Consumo:

18 μ A em stand-by
4,5 mA no início de atividade
300 mA quando o motor gira

Força que o componente de bloqueio pode exercer

10N com alimentação a 9VDC.

Materiais da unidade de armazenamento onde se pode fixar a fechadura

Materiais metálicos ou compósitos resistentes ao aparafusamento e aperto.

Dimensões dos orifícios das fechaduras, hastes ou passagens de cabos

Orifício de passagem do cabo que liga a unidade de segurança ao terminal: Orifício redondo de diâmetro entre 5 e 13 mm.

Dimensões mecânicas:

Terminal:

P = 90 mm
A = 35 mm

Unidade de segurança:

L = 87 mm
A = 61 mm
P = 36 mm

Ambiente:

Temperatura de funcionamento:
-10 a +55°C

Humidade relativa:
20 a 80 %

Recomendações relativas à proteção das fechaduras contra ataques destrutivos

O orifício de passagem do cabo que liga a unidade de segurança ao terminal deve ser desviado em relação à posição da unidade de segurança.

Instalação dos contactos de pernos







Os contactos de pernos são microswitchs idealmente situados diretamente nas peças de serralharia ou, caso contrário, na parte móvel da ligação.

O contacto do microswitch deve ser pressionado quando o cofre está fechado.

INHOUDSOPGAVE

1. Inleiding	148
1.1 Omschrijving van het product.....	148
1.2 Signalen	149
1.3 Toegangsniveau gebruikers	149
1.4 Openingscode.....	149
2. Gebruik van het slot	150
2.1 Voeding.....	150
2.2 De batterij plaatsen	150
2.3 De deur openen.....	151
2.4 De deur beveiligen.....	152
3. Configuratie van het systeem (geavanceerde gebruiker)	153
3.1 Een openingscode wijzigen	153
3.2 De gebruikers activeren en deactiveren	154
3.3 De vertragingen afstellen	156
3.4 Dualmodus (vier ogen).....	158
3.5 Procedure onder dwang	160
3.6 De code na vertraging herhalen	163
3.7 Geluidsignaal	165
4. Auditfunctie van de sloten	167
5. Troubleshooting	168
6. Garantie	168
7. Fabrieksinstelling	169
8. Technische Specificaties	170

Signalen:

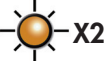
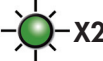
		Uit
		Aan
		Knippert
		Knippert twee keer

1. Inleiding

Dank voor uw aankoop.

Met dit slot kunt u de toegang tot uw bezittingen controleren en beveiligen.

Het slot biedt diverse configuratiemogelijkheden.

1.1 Omschrijving van het product

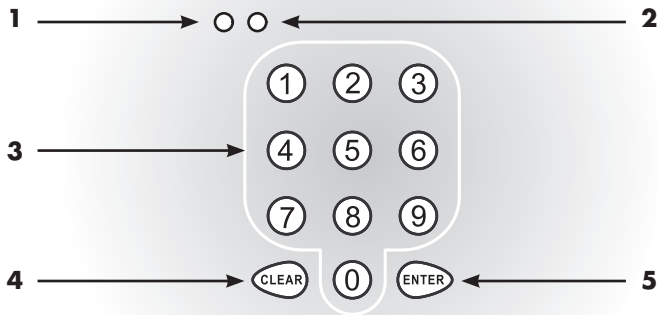

1 - Oranje controlelampje.

2 - Groen controlelampje.

3 - Toetsenbord: telkens u op een toets drukt, hoort u een piepsignaal.

4 - Toets "**Clear**": met deze toets kunt u het slot handmatig vergrendelen en ingevoerde codes wissen.

5 - Toets "**Enter**": met deze toets kunt u de invoer bevestigen.



1.2 Signalen

Elke correcte actie wordt bevestigd met een geluidssignaal bestaande uit 2 blieps; daarbij knippert het groene lampje 2 keer.

Elke verkeerde actie wordt bevestigd met een geluidssignaal bestaande uit 3 blieps; daarbij knippert het oranje lampje 3 keer.

1.3 Toegangs niveau gebruikers

Er zijn drie toegangs niveaus:

- 1 master.
- 7 gebruikers.
- 1 C.I.T. (Geldtransport).

Alleen met de mastercode kan een code geactiveerd, gedeactiveerd of gewijzigd worden. Met de mastercode, de codes van de gebruikers en de C.I.T.-code kan het slot geopend worden.

Om te vermijden dat u uw slot niet meer kunt openen omdat u uw code vergeten bent, raden wij u aan minimaal twee geactiveerde openingscodes te voorzien.

1.4 Openingscode

Een openingscode kan bestaan uit 6, 7 of 8 cijfers.

De verschillende standaardcodes staan vermeld in hoofdstuk 7: "Fabrieksinstelling".



Met het oog op een optimale veiligheid, gelieve volgende codes niet te gebruiken: 000000....999999, 1234567, 7654321, enz.

2. Gebruik van het slot

2.1 Voeding

Het slot kan gevoed worden:

- met een batterij (autonoom gebruik).
- met een externe voeding (optioneel, aanbevolen bij intensief gebruik of voor de parameterinstelling van vertragingen).

2.2 De batterij plaatsen

Wanneer het oranje lampje knippert, is uw batterij leeg en dient u ze te vervangen:

- ☞ De invoereenheid tegen de wijzers van de klok in draaien.
- ☞ Het toetsenbord van de invoereenheid verwijderen.
- ☞ Aankoppelen en de batterij plaatsen (gebruik een alkalinebatterij 9 volt: type 61R61).
- ☞ Van zodra de batterij aangesloten is, moet het slot de handeling bevestigen met 2 blieps.
- ☞ De invoereenheid sluiten zonder de elektrische kabels plat te drukken en ze vergrendelen door ze met de wijzers van de klok mee te draaien.
- ☞ Telkens het slot geactiveerd wordt, klinkt een geluidssignaal gedurende 3 seconden (het slot wordt geactiveerd wanneer men op een toets drukt na ten minste 10 seconden inactiviteit van het slot) en dit zolang het slot niet volledig geopend is.

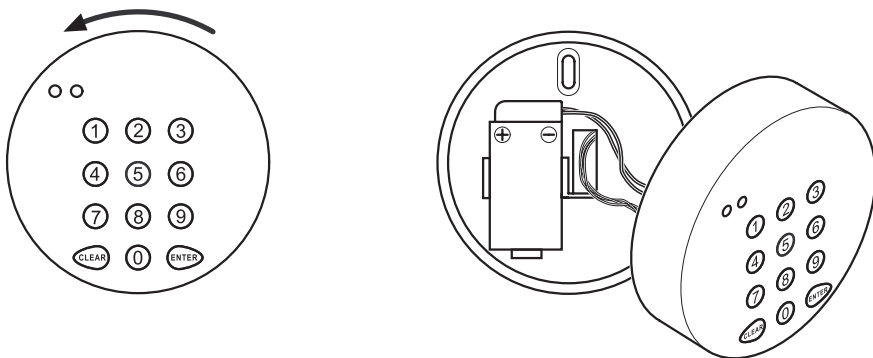

De codes, afstellingen en blokkeringen worden opgeslagen en beveiligd tegen stroomonderbrekingen.

2.3 De deur openen

Na instelling van de parameters kan het slot op verschillende manieren geopend worden:

2.3.1 Openen zonder vertraging

Oranje controlelampje

Groen controlelampje

☞ Een openingscode invoeren +  en wachten zolang het groene controlelampje knippert.



☞ Wanneer het groene controlelampje brandt, kunt u de deur openen.



2.3.2 Openen met vertraging

Oranje controlelampje

Groen controlelampje

☞ Een openingscode invoeren +  en wachten zolang het groene en het oranje controlelampje knipperen.



☞ Wanneer er blieps klinken, uw openingscode opnieuw invoeren.



☞ Wanneer het groene controlelampje brandt, kunt u de deur openen.



Blokkering verkeerde code:



- Indien u drie verkeerde codes invoert, wordt het slot 10 minuten geblokkeerd.
- Indien u de vierde keer een verkeerde code invoert, wordt het slot 20 minuten geblokkeerd.
- Na elke nieuwe poging wordt het slot 30 minuten geblokkeerd.











- De C.I.T.-code heeft geen vertraging.
- Na de eerste opening moet de in de fabriek ingestelde code door een veiligere code vervangen worden.











De deur openen







2.3.3 Openen in Dualmodus (vier ogen) zonder vertraging

	Oranje controlelampje	Groen controlelampje
☞ Een openingscode invoeren + 		
☞ Wanneer er blieps klinken, een tweede openingscode invoeren + 		
☞ Wanneer het groene controlelampje brandt, kunt u de deur openen.		

2.3.4 Openen in Dualmodus (vier ogen) met vertraging

	Oranje controlelampje	Groen controlelampje
☞ Een openingscode invoeren + 		
☞ Wanneer er blieps klinken, een tweede openingscode invoeren + 		
☞ Wanneer er blieps klinken, de tweede openingscode opnieuw invoeren + 		
☞ Wanneer het groene controlelampje brandt, kunt u de deur openen.		

2.4 De deur beveiligen

	Oranje controlelampje	Groen controlelampje
☞ De deur sluiten en vergrendelen.		
☞ Het slot wordt automatisch vergrendeld.		





















Noot: Indien de deur niet geopend werd, op  drukken om het slot te vergrendelen en de deur te beveiligen.



3. Configuratie van het systeem (geavanceerde gebruiker)

Wij raden u aan elke configuratiewijziging met geopende deur uit te voeren.

3.1 Een openingscode wijzigen

	Oranje controlelampje	Groen controlelampje
☞ De mastercode invoeren + 		
☞ Wanneer het groene controlelampje brandt, kunt u de deur openen.		
*☞ Met geopende deur de mastercode opnieuw invoeren + 		
☞ Een gebruiker kiezen (9 mogelijkheden) en het volgende invoeren:		
- "0" +  voor de mastercode.		
of		
- "1" +  voor gebruiker 1.		
of		
- "7" +  voor gebruiker 7.		
of		
- "8" +  voor de C.I.T._gebruiker.		
☞ De nieuwe code invoeren + 		 X2
☞ De nieuwe code opnieuw invoeren + 		 X2

Indien u een andere parameter wenst te wijzigen, de stappen herhalen vanaf het*



- Een toegangscode kan bestaan uit 6, 7 of 8 cijfers.
- Een code kan gewijzigd worden, zelfs indien de gebruiker niet geactiveerd is.

3.2 De gebruikers activeren en deactiveren

3.2.1 De gebruikers activeren

	Oranje controlelampje	Groen controlelampje
☞ De mastercode invoeren +		
☞ Wanneer het groene controlelampje brandt, kunt u de deur openen.		
* ☞ Met geopende deur de mastercode opnieuw invoeren +		
☞ "9" invoeren +		X2
☞ Een gebruiker kiezen (8 mogelijkheden) en het volgende invoeren:		
- "1" + voor gebruiker 1. of - "2" + voor gebruiker 2. . of . . - "7" + voor gebruiker 7. of - "8" + voor de C.I.T._gebruiker.		X2
☞ "1" invoeren + De gebruiker is geactiveerd.		X2



















Indien u een andere parameter wenst te wijzigen, de stappen herhalen vanaf het *

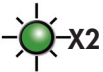

Na de eerste activering van een gebruiker, de standaardcode vervangen door een veiligere code.

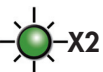

3.2.2 De gebruikers deactiveren

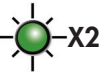
	Oranje controlelampje	Groen controlelampje
☞ De mastercode invoeren + 		
☞ Wanneer het groene controlelampje brandt, kunt u de deur openen.		
*☞ Met geopende deur de mastercode opnieuw invoeren + 		
☞ "9" invoeren + 		
☞ Een gebruiker kiezen (8 mogelijkheden) en het volgende invoeren:		
- "1" +  voor gebruiker 1. of - "2" +  voor gebruiker 2. . . . of - "7" +  voor gebruiker 7. of - "8" +  voor de C.I.T._gebruiker.		
☞ "0" invoeren +  De gebruiker is gedeactiveerd.		

Indien u een andere parameter wenst te wijzigen, de stappen herhalen vanaf het *



Zelfs indien een gedeactiveerde code geen vergrendeling toelaat, blijft ze in het geheugen opgeslagen.

3.3 De vertragingen afstellen

Voor het slot kan een openingsvertraging geprogrammeerd worden. Wanneer u uw openingscode invoert, verloopt er een bepaalde, voorgeprogrammeerde vertragingstijd voor het slot ontgrendeld wordt.

De duur van de vertragingen ligt tussen "0" en "99" minuten.

3.3.1 Vertraging master

	Oranje controlelampje	Groen controlelampje
De mastercode invoeren +		
Wanneer het groene controlelampje brandt, kunt u de deur openen.		
Met geopende deur de mastercode opnieuw invoeren +		
"13" invoeren +		
"de vertraging in minuten" invoeren +		



Voor een intensief gebruik van het slot met vertraging, raden wij u aan uw slot met een externe 12V-voeding te verbinden (optioneel).



















De vertragingen afstellen



F

GB

3.3.2 Vertraging gebruikers

	Oranje controlelampje	Groen controlelampje
 De mastercode invoeren + 		
 Wanneer het groene controlelampje brandt, kunt u de deur openen.		
 Met geopende deur de mastercode opnieuw invoeren + 		
 "14" invoeren + 		
 "de vertraging in minuten" invoeren + 		

E

D

I

P



Voor een intensief gebruik van het slot met vertraging, raden wij u aan uw slot met een externe 12V-voeding te verbinden (optioneel).

NL



















Dualmodus (vier ogen)

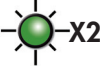

3.4 Dualmodus (vier ogen)

In de Dualmodus dient u 2 gebruikerscodes in te voeren om het slot te kunnen ontgrendelen.

3.4.1 De Dualmodus activeren (vier ogen)

	Oranje controlelampje	Groen controlelampje
 De mastercode invoeren + 		
 Wanneer het groene controlelampje brandt, kunt u de deur openen.		
 Met geopende deur de mastercode opnieuw invoeren + 		
 "12" invoeren + 		
 "1" invoeren +  De functie is geactiveerd.		



Zelfs in Dualmodus (vier ogen) kan de deur ontgrendeld worden met alleen de mastercode of de C.I.T.-code.





















In Dualmodus (vier ogen) is de openingsvertraging de vertraging van de tweede code.

Dualmodus (vier ogen)



3.4.2 De Dualmodus deactiveren (vier ogen)

	Oranje controlelampje	Groen controlelampje
 De mastercode invoeren + 		
 Wanneer het groene controlelampje brandt, kunt u de deur openen.		
 Met geopende deur de mastercode opnieuw invoeren + 		
 "12" invoeren + 		
 "0" invoeren +  De functie is gedeactiveerd.		

F

GB

E

D

I

P

NL















3.5 Procedure onder dwang

Indien u bedreigd zou worden tijdens het invoeren van uw code, kunt u met de functie alarm onder dwang het slot ontgrendelen door een specifieke vertraging toe te passen en/of een alarm inschakelen om de bewakingsagenten te waarschuwen.

De procedure onder dwang wordt geactiveerd door het laatste cijfer van de code met 1 te vermeerderen of te verminderen.

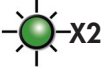
Voorbeelden: 156754 → 156753 of 156755.
142789 → 142788 of 142780.

3.5.1 De procedure onder dwang activeren

	Oranje controlelampje	Groen controlelampje
☞ De mastercode invoeren + 		
☞ Wanneer het groene controlelampje brandt, kunt u de deur openen.		
☞ Met geopende deur de mastercode opnieuw invoeren + 		
☞ "11" invoeren + 		
☞ "1" invoeren +  De functie is geactiveerd.		















Om een alarm via de procedure onder dwang te kunnen inschakelen, dient uw slot aan een alarmcentrale gekoppeld te zijn, die met een bewakingsysteem op afstand verbonden is.

Procedure onder dwang

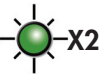

3.5.2 De procedure onder dwang deactiveren

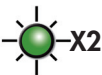
	Oranje controlelampje	Groen controlelampje
☞ De mastercode invoeren + 		
☞ Wanneer het groene controlelampje brandt, kunt u de deur openen.		
☞ Met geopende deur de mastercode opnieuw invoeren + 		
☞ "11" invoeren + 		
☞ "0" invoeren +  De functie is gedeactiveerd.		

F

GB

E

D

I

P

NL

3.5.3 Vertraging procedure onder dwang

De duur van de vertragingen ligt tussen "0" en "99" minuten.

	Oranje controlelampje	Groen controlelampje
De mastercode invoeren +		
Wanneer het groene controlelampje brandt, kunt u de deur openen.		
Met geopende deur de mastercode opnieuw invoeren +		
"15" invoeren +		
"de vertraging in minuten" invoeren +		



Wanneer de Dualmodus (vier ogen) geactiveerd is, kan alleen de tweede gebruiker de vertraging onder dwang activeren.





















3.6 De code na vertraging herhalen

Wanneer u een openingsvertraging op uw slot geprogrammeerd hebt, kunt u kiezen of u uw code na de vertraging al dan niet opnieuw moet invoeren om uw slot te ontgrendelen.

Standaard is het opnieuw invoeren van de code geactiveerd, zie **hoofdstuk 7: "Fabrieksinstelling"**.

3.6.1 Herhaling van de code na vertraging activeren

	Oranje controlelampje	Groen controlelampje
 De mastercode invoeren + 		
 Wanneer het groene controlelampje brandt, kunt u de deur openen.		
 Met geopende deur de mastercode opnieuw invoeren + 		
 "17" invoeren + 		
 "1" invoeren +  De functie is geactiveerd.		

De code na vertraging herhalen



3.6.1 Herhaling van de code na vertraging deactiveren

	Oranje controlelampje	Groen controlelampje
De mastercode invoeren +		
Wanneer het groene controlelampje brandt, kunt u de deur openen.		
Met geopende deur de mastercode opnieuw invoeren +		
"17" invoeren +		
"0" invoeren + De functie is gedeactiveerd.		



3.7 Geluidsignaal

U kunt ervoor kiezen om uw slot in geluidloze modus (geneutraliseerde zoemer) te laten functioneren.

3.7.1 Het geluidsignaal activeren



















	Oranje controlelampje	Groen controlelampje
De mastercode invoeren +		
Wanneer het groene controlelampje brandt, kunt u de deur openen.		
Met geopende deur de mastercode opnieuw invoeren +		
"10" invoeren +		
"1" invoeren + De functie is geactiveerd.		



Opgelet: wij vestigen uw aandacht op het feit dat het gebruik van het slot in geluidloze modus minder intuïtief is. Deze functie moet dus voorbehouden worden aan gebruikers die het gebruik van het slot goed beheersen.

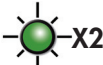

3.7.2 Het geluidsignaal deactiveren

	Oranje controlelampje	Groen controlelampje
 De mastercode invoeren + 		
 Wanneer het groene controlelampje brandt, kunt u de deur openen.		
 Met geopende deur de mastercode opnieuw invoeren + 		
 "10" invoeren + 		
 "0" invoeren +  De functie is gedeactiveerd.		



Alleen de alarmen blijven hoorbaar wanneer het geluidsignaal gedeactiveerd is (zie Troubleshooting).



4. Auditfunctie van de sloten

Een slot uitgerust met de Auditfunctie kan tot 500 gebeurtenissen (permanent) in het geheugen opslaan.

Om de gebeurtenissen in het slot te kunnen oproepen, hebt u een BTXN-bediening, een PC-verbindingkabel en de software XN_Tool nodig, zodat u de gegevens kunt gebruiken. Met de BTXN-bediening kunt u de gebeurtenissen van 16 sloten oproepen.

Deze onderdelen zijn optioneel (gelieve uw verdeler te contacteren).



5. Troubleshooting

- Het oranje controlelampje knippert een tiental keer traag.

⇒ De batterij van uw slot is leeg: u dient ze te vervangen.

- Het oranje controlelampje knippert drie keer nadat u op een toets gedrukt hebt.

⇒ Het slot is geblokkeerd na verkeerde code (invoer van minstens 3 verkeerde codes na elkaar): het einde van de blokkering afwachten voor u een nieuwe poging onderneemt (zie hoofdstuk 2.3).

- Het oranje controlelampje knippert en het geluidsignaal blijft twee keer.

⇒ Het openingsmechanisme wordt belemmerd: uw verdeler contacteren.

- Het slot geeft een lang geluidsignaal nadat u op een toets gedrukt hebt.

⇒ De invoereenheid is geopend: dit signaal verdwijnt bij de volgende opening.

- Het groene en oranje controlelampje knipperen tegelijkertijd en het slot geeft twee bleeps.

⇒ De verbinding tussen de invoereenheid en de beveiligingseenheid (binnen in de koffer) is niet correct gemaakt: uw verdeler contacteren.

6. Garantie

De verdeler van uw koffer is de eerste persoon die mag ingrijpen, mocht dit nodig zijn. Gelieve (indien u verhuist, indien de winkel waar u uw koffer gekocht hebt gesloten is, ...) de Servicedienst te contacteren, die u het adres zal geven van een bevoegde verdeler van het merk in uw buurt.

Bij interventie aan uw toestel dient u van de Servicedienst te eisen dat de gebruikte reserveonderdelen het certificaat Constructeur hebben.

Wanneer u de Servicedienst belt, gelieve dan het model en het registratienummer van uw koffer te vermelden.



Wij kunnen niet aansprakelijk gesteld worden voor eventuele problemen met een gewijzigd slot of met een slot waarvoor niet de originele onderdelen gebruikt zijn.



7. Fabrieksinstelling

Standaardfabriekinstellingen

		Standaardopeningscode	
Configuratie van de code	Master	000000	Geactiveerd
	Gebruiker 1	111111	Gedeactiveerd
	Gebruiker 2	222222	Gedeactiveerd
	Gebruiker 3	333333	Gedeactiveerd
	Gebruiker 4	444444	Gedeactiveerd
	Gebruiker 5	555555	Gedeactiveerd
	Gebruiker 6	666666	Gedeactiveerd
	Gebruiker 7	777777	Gedeactiveerd
	C.I.T.	888888	Gedeactiveerd

Vertraging	Vertraging code master	0 min
	Vertraging code gebruikers	0 min
	Vertraging procedure onder dwang	0 min

Afstelling	Geluidsignaal	Geactiveerd
	Vier-ogenmodus	Gedeactiveerd
	Relaiskabel	Gedeactiveerd
	Procedure onder dwang	Gedeactiveerd
	Herhaling van de code na vertraging	Geactiveerd



8. Technische Specificaties

Elektrische gegevens van het **Nectra** combinatieslot:

Voedingsspanning:

Een 9 Volt alkalinebatterijen
550 mAh type 6LR61
Externe voeding

Voedingsspanning:

8 volts - 18 volts

Stroomverbruik:

18 μ A in rust
4.5 mA bij opstarten
300 mA bij draaiende motor

Kracht die de grendel kan uitoefenen

10N met een voeding van 9V DC.

Materiaal van de opslagunit waarop het slot kan worden bevestigd

Metaal of composietmateriaal dat bestand is tegen schroeven en aandraaien.

Afmetingen van de gaten voor de sloten, stangen of kabels

Kabelgat voor de verbinding tussen de beveiligingsunit en de terminal: een rond gat met een diameter van 5 tot 13 mm.

Mechanische afmetingen:

Terminal:

Dia = 90 mm
H = 35 mm

Veiligheidsunit:

L = 87 mm
H = 61 mm
P = 36 mm

Omgeving:

Bedrijfstemperatuur:

-10 bis +55°C

Vochtigheid:

20 bis 80 %

Aanbevelingen om de sloten te beschermen tegen aanvallen

Het kabelgat voor de verbinding tussen de beveiligingsunit en de terminal moet verwijderd zijn van de positie van de beveiligingsunit.

Installatie van de schootcontacten

De schootcontacten zijn microschakelaars die bij voorkeur rechtstreeks op de onderdelen van het slot worden geplaatst, of anders op het mobiele deel van het sluitmechanisme.

Het contact van de microschakelaar moet ingedrukt zijn als de kluis is gesloten.

Cachet de votre revendeur :

Authorised dealer:



FICHET CENTRE RELATION CLIENTS

Des techniciens partout en France, un seul numéro pour les joindre,

Tél. : 01 78 42 56 56

fichetcrc@fichetgroup.com

Find your Fichet Customer Service Support: www.fichet-bauche.com



Fichet – Bauche
15 rue Fichet-Bauche
51110 Bazancourt